

Preisliste 2023

Version 01.2023

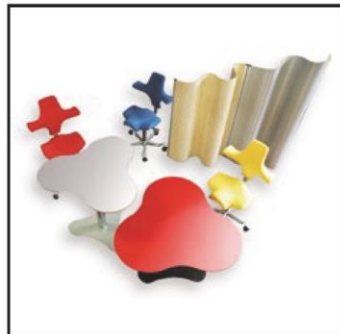



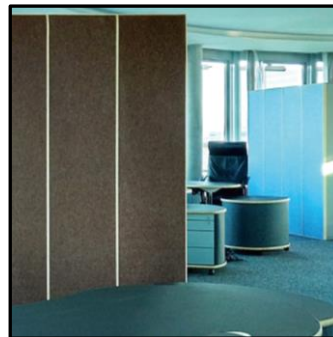

Vital-Office®













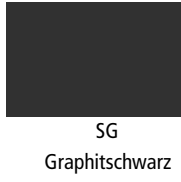

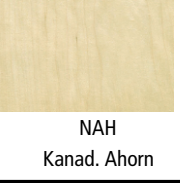

Rolladenschränke,
Caddies und
Container mit
Mehrwert durch
integrierte
Akustikabsorber
(in Lizenz von EP 3241462)



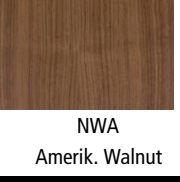
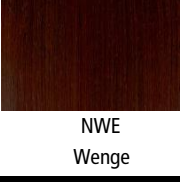

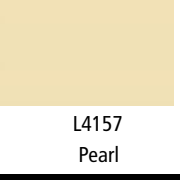
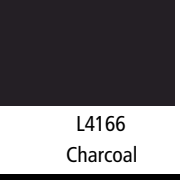

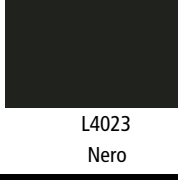
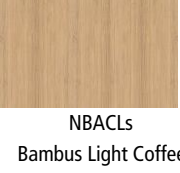





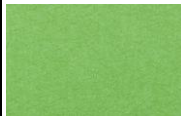







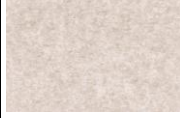
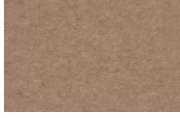

Preisliste 2023

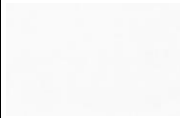
Inhalt:	
6-10	Schreibtische
11-17	Container und Caddy
18-19	Varitable Anstell- und Besprechungstische
20	Flexiconference Schulungsraum
21-24	Variconference Konferenztische
25	Qiboard Sideboards
26-38	Modulschranksystem
39	WEY-chair
40-41	circon Designklassiker und exklusive Konferenzenanlagen
42-46	Akustikabsorber, Flächenvorhänge, Baffeln, Partitionen
47-48	Muster, Ausschreibungstexte, Dienstleistungen (Lieferung und Montage)

Modular Baukasten	<p>Das Vital-Office System ist modular aufgebaut. Z.B. sind Schreibtische aus verschiedenen Tischplattenformen und Größen mit verschiedenen Gestelltypen frei kombinierbar. Die Variantenvielfalt ist sehr hoch. Aus diesem Grund sind in dieser Preisliste die Teile getrennt aufgeführt. Eine Plausibilitätskontrolle ist im OFML CAD Konfigurator enthalten. Alternativ stehen wir und unsere Partner gerne beratend zur Verfügung.</p>
Profilierte Tischplatten	<div style="display: flex; justify-content: space-around; align-items: center;">      </div> <p>Vital-Office Tischplatten sind in verschiedenen Kantenprofilen lieferbar. Dadurch wird der gestalterischen Individualisierung in Stil und Design entsprochen. Tische mit C-Profil unterscheiden sich sehr stark von Tischen mit B- oder T-Profil.</p>
Fühlbare Natürlichkeit	<p>Umweltschädliche Plastikkanten an billigen Spanplatten sind „out“: Fühlbare Natürlichkeit steht für ehrliches und ökologisches Design. Die Vital-Office Tischplatten sind aus homogenem Holz-Material gefertigt und werden wie eine Skulptur modelliert sowie natürlich gewachst oder geölt. (Ein Anleimer, der die rohe Spanplattenkante abdeckt ist bei Vital-Office Platten NICHT erforderlich.)</p>
Preisliste	<p>Diese Preisliste ist ausschließlich für Distributoren und Großkunden bestimmt. Sie ist nur gültig in Verbindung mit einem Liefervertrag, der die Lieferbedingungen und Serviceleistungen von der Planung bis zur Endmontage beim Anwender regelt. Alle Preise sind UVP in EURO exklusive gesetzliche Mehrwertsteuer. Alle bisherigen Preislisten/Preisblätter treten mit Erscheinen dieser Preisliste außer Kraft. Es gilt ausschließlich unsere AGB: www.vital-office.de/agb</p>
Garantie	<p>5 Jahre Garantie (auf alle nicht beweglichen Möbelteile) Für bewegliche Teile, z.B. motorische Gestelle gewähren wir Garantie gemäß den gesetzlichen Bestimmungen. Ersatzteile werden zum Erfüllungsort geliefert. (Das ist i.d.R. das Händlerlager.)</p>
Auftragsänderung	<p>Stornierungen und Änderungen sind nur solange möglich, wie der Auftrag noch nicht in der Produktion bearbeitet wurde und keine Materialien dafür bei Vorlieferanten bestellt wurden. Da wir ein sehr umfangreiches Sortiment anbieten und variable Lieferzeiten haben ist dieser Zeitpunkt nicht generell definierbar. I.d.R. sind Änderungen maximal 3 Arbeitstage nach Erhalt der Auftragsbestätigung möglich. Bitte erkundigen Sie sich vor Stornierung oder Änderung bzgl. der Kosten.</p>
Lieferzeit und Lieferung	<p>Standardprodukte in Standardoberflächen, die ausreichend am Lager sind, können wir innerhalb von 4-6 Wochen ausliefern. Alles andere i.d.R. innerhalb von 6-10 Wochen. Die Lieferung erfolgt ab Werk per Spedition. Tischplatten und Gestelle sind auf Grund des hohen Gewichts getrennt und die Gestellteile sind transporttechnisch zerlegt und verpackt. Optional bieten wir einen Montageservice nach Aufwand oder Pauschale an. Siehe Preisliste Dienstleistungen.</p>
Sonder und Aufschläge	<p>Wir sind heute bestens organisiert. Standardteile sind ERP, CAD und CNC programmiert und können auftragsbezogen mit den voreingestellten Varianten abgerufen werden. Darüber hinausgehende Sonderwünsche sind daher nur mit einem entsprechenden Programmieraufwand oder Handarbeit möglich. Hierfür erheben wir einen Grundzuschlag von 100,- € plus 15% auf den Produktpreis. Wir empfehlen, vorher ein konkretes Angebot bei uns einzuholen. Weitere Mindestmehrzuschläge für Sondermaterial finden Sie in der Preisliste.</p>
Service	<p>Vital-Office steht für zufriedene Kunden und Kontinuität. Dies wird dadurch gewährleistet, dass wir uns bereits in der Planungsphase um Ihr Büro kümmern. Unsere geschulten Architekten planen Ihr Büro unter Berücksichtigung aller relevanten Faktoren, auch wenn Sie letztlich nur die Möbel bei uns kaufen. Geben Sie unseren Architekten die Möglichkeit mit Ihnen zu kommunizieren, Ihre Wünsche und Bedürfnisse aufzunehmen und Ihnen damit Ihr Wohlfühlbüro mit Zufriedenheitsgarantie zu erarbeiten.</p>

Melamin Direktbeschichtung 25mm MDF + 19mm Dekorspan	ACKW kristallweiß (9016)	Tischplatten = 25mm MDF plus Beschichtung mit Profilkanten MDF gewachst a) Melamin Direktbeschichtung beidseitig b) HPL einseitig mit Gegenzug weiß Korpusteile (Blenden+Schränke) = 19mm Dekorspan mit ABS Kanten			
Laminat (HPL) 19/25mm MDF/Span + HPL		UGW (Auslaufend) grauweiß (9002)	 DBA (Ersatz f. DBH) Bergahorn	 AL Alu strichmatt	 SG Graphitschwarz
Echtholz Furnier Standardfurniere	 NEI Eiche	 NBU Buche	 NEN Esche	 NBAHs Bambus hell (natur)	 NBACs Bambus Coffee
Echtholz Furnier Edelfurniere +35% Zuschlag	 NAH Kanad. Ahorn	 NBI Schweizer Birne	 NKI Europ. Kirsche	 NES Esche schwarz	 NEI Eiche schwarz
Echtholz Furnier Edelfurniere +35% Zuschlag	 NWA Amerik. Walnut	 NWE Wenge	 NMA Mahagoni		weitere Furniere siehe www. sg-veneers.com /furnierwelt
Linoleum* Preisgruppe Laminat weitere Farben siehe Forbo.com -> Furniture Linoleum	 L4157 Pearl	 L4166 Charcoal	 L4164 Salsa	 L4023 Nero	
Massivholz Bambus 20mm	 NBAHs Bambus hell (natur)	 NBACs Bambus Light Coffee	Schmallamelle ca. 6mm breite Lamellen	 C2 mattchrom Metallbogengriff	 C3 mattchrom Metallbogengriff

weitere Oberflächen auf Anfrage (z.B. für Konferenztische: lackiertes Glas, Hochglanz, Metall-Lamine, uvm)	
Linoleum wird in Preisgruppe FURNIER berechnet und Lamine z.B. aus Kollektionen Formica oder Pfeleiderer werden i.d.R. in Preisgruppe Laminat berechnet. Wegen der hohen Preisunterschiede bitten wir vorab um Ihre Anfrage!	
Lackierte Oberflächen (Schleiflack matt) in allen RAL Farben uvm. wird in Preisgruppe Furnier mit + 100% Zuschlag berechnet	
Bitte beachten Sie die Mindestmengenzuschläge für Laminat, Linoleum und Lack pro Farbe und Auftrag:	+120 €
Tischplatten mit MDF und Melamin/HPL/Lino Oberfläche können farbig lackierte Kanten haben: Mehrpreis:	+238 €

vitAcoustic PREMIUM PET	weitere PET Farben auf Anfrage (bis zu 50 Farben)	 PM843 Spring Green	 PM851 Green	 PM814 Light blue	 PM825 Sky
	 PM805 Yellow	 PM846 Orange	 PM808 Royal Red	 PM850 Purple	 PM801 Deep Ocean
	 PM804 Sand	 PM844 Sepia	 PM839 Dark brown	 PM817 Fern	 PM819 Dark blue
	 PM807 White	 PM830 Stone	 PM836 Marble grey	 PM837 Graphit	 PM813 Black
vitAcoustic mit echtem Moos	 PMEG15 Apple green	 PMEG26 Moss green	 PMHL15 Hill Apple green	 PMHL26 Hill Moss green	

** Bei allen PET Filzplatten sind chargenbedingte Farbabweichungen möglich!

Akustik Absorption 9mm Premium PET 2.0kg/m² = Höchstabsorbierend Klasse B $\alpha_w = 0.80$

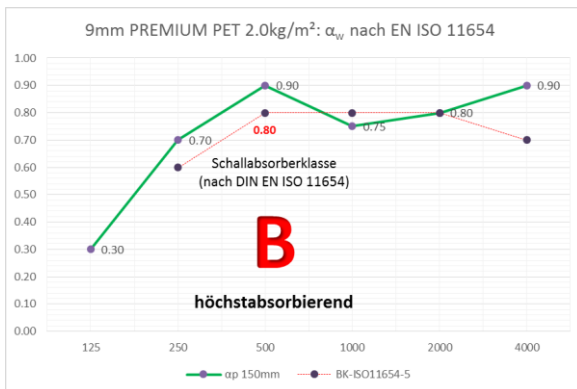

Upgrade 2x9mm = 18mm: Aufpreis 100%

Akustik Absorption 18mm Premium PET 4.0kg/m² = Höchstabsorbierend Klasse A $\alpha_w = 0.95$

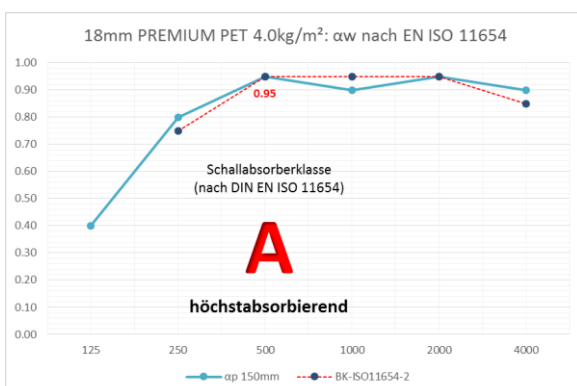

Wählen Sie Tischplattenform und Größe



MDF 28 beschichtet



Bambus Massivholz



Profilkanten:



Feng Shui optimierte und ausgezeichnete authentisch runde Tischplatten	8d1b33 Joker 146 / 8d1b33 1462x857mm	8d1b45 Joker 168 / 8d1b45 1686x897mm	8d2b45 Joker 191 / 8d2b45 1910x1005mm	8d2b55 Joker 210 / 8d2b55 2100x1049mm	8d2b65 Joker 231 / 8d2b65 2315x1111mm
Facettierte Tischplatten		8d2c35 Diamond 168 / 8d2c35 1686x962mm	8d2c45 Diamond 191 / 8d2c45 1910x992mm	8d2c50 Diamond 210 / 8d2c50 2100x1017mm	
Feng Shui optimierte runde Tischplatten FormFit zur Kombination mit Akustik Caddies und Variable		8d3b35 Joker F168 / 8d3b35 1772x957mm		8d3b50 Joker F210 / 8d3b50 2040x1027mm	
Derivate	Facettierte Tischplatten FormFit	8d3c35 Diamond F168 / 8d3c35 1686x962mm		8d3c50 Diamond F210 / 8d3c50 2040x1003mm	
Runde Tischplatten FormFit zur Kombination mit geraden Caddies				8d3be50 Joker FG210 / 8d3be50 2040x1027mm	
Derivate	Facettierte Tischplatten FormFit Gerade (für Caddy)			8d3ce50 Diamond FG210/8d3ce50 2040x1003mm	
Feng Shui optimierte runde Tischplatten in 8-Form für Kommunikation, Büro und Zuhause		infinity 168 / 8d1dd168 1686x810mm	infinity 191 / 8d2dd191 1910x1005mm		infinity 231 / 8d2dd231 2315x905mm

Listenpreise UVP nach Preisgruppe

25mm MDF Melamin	568 €	600 €	690 €	708 €	994 €
25mm MDF Laminat*	776 €	820 €	950 €	1'125 €	1'379 €
25mm MDF Furnier	852 €	923 €	1'124 €	1'162 €	1'519 €
Bambus 20mm	877 €	901 €	973 €	1'222 €	1'278 €

Option Lackkante*





+238 €

+Mindestmengenzuschlag für Laminat, Linoleum+Lack/Farbe+Auftrag:

+120 €

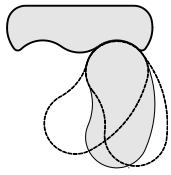
Tischplatten

Wählen Sie Tischplattenform und Größe

					
	Sidewave T168 / 8d1swt für 146+168 1890x618mm	Sidewave G168 / 8d1swg für 146+168 1769x618mm		Sidewave T191/8d2swt für 191+210+231 2129x659mm	Sidewave G191/8d2swg für 191+210+231 1890x659mm

Listenpreise UVP nach Preisgruppe

25mm MDF Melamin	582 €	582 €		624 €	582 €
25mm MDF Laminat*	789 €	789 €		998 €	789 €
25mm MDF Furnier	860 €	860 €		947 €	860 €
Bambus 20mm	886 €	886 €		1'153 €	886 €



Option Lackkante*

+238 €

+Mindestmengenzuschlag für Laminat, Linoleum+Lack/Farbe+Auftrag*

+120 €

Wählen Sie Tischplattenform und Größe

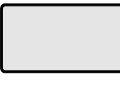
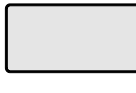
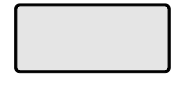
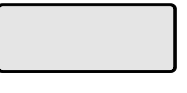
					
Ecken R=30mm	KT1208 / BC7128-Mp	KT1608 / BC7168-Mp	KT1808 / BC7188-Mp	KT2008 / BC7208-Mp	KT2308 / BC7238-Mp

Listenpreise UVP nach Preisgruppe

25mm MDF Melamin	397 €	562 €	592 €	622 €	667 €
25mm MDF Laminat*	560 €	766 €	806 €	846 €	1'060 €
25mm MDF Furnier	629 €	831 €	895 €	959 €	1'055 €
Bambus 20mm	663 €	872 €	895 €	917 €	1'186 €

Option Lackkante*

+238 €

+Mindestmengenzuschlag für Laminat, Linoleum+Lack/Farbe+Auftrag:

+120 €

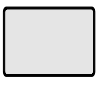
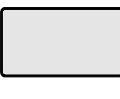
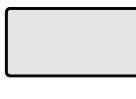
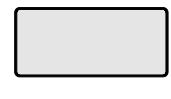
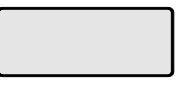
					
Ecken spitz (2mm Kantenrundung)	KT1208 / BC7128-S3	KT1608 / BC7168-S3	KT1808 / BC7188-S3	KT2008 / BC7208-S3	KT2308 / BC7238-S3

Listenpreise UVP nach Preisgruppe



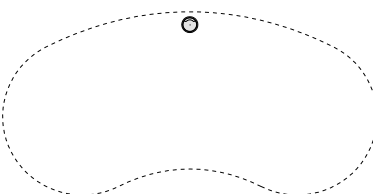
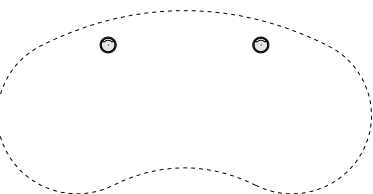

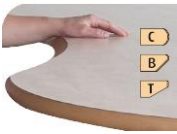

25mm Melamin	149 €	189 €	200 €	210 €	226 €
Bambus 20mm	542 €	727 €	737 €	748 €	999 €

Standardpositionen für Kabeldurchführungen			Mehrpreis für Sonderpositionen nach Maßangabe (Programmier-aufwand)
	1 Kabeldurchführung	2 Kabeldurchführungen	

Wählen Sie Optionen, Kabelführung, CPU Halter, Medientechnik

Prävention:
Karpaltunnelsyndrom



 ErgoComfort Kante (Softtouch) Vorne ST 63 €	 Kabeldurchführung in Metall KDB-V2A 23 €	 flexible Kabelhalter bcb402 4 €	 Kabelkanal bcb404 53 €	 CPU Halter (Gurt) bcb510 21 €	 Lochblech Abdeckung alufarben bcb513 83 €
---	--	--	--	--	--







Vorteil: Hier kann man
drauftreten



 Powerflex 125cm mit Fußteil transparent bcb411-TR 63 €	 Powerflex 125cm mit Fußteil schwarz BCB411-SW 63 €	 Powerflex Verlängerung 100cm transparent bcb412-TR 57 €	 Powerflex Verlängerung 100cm schwarz bcb412-SW 57 €	 CPU Halter bcb512 90 €	 Unterlage schwarz STZ-FU01 38 €
--	--	---	--	---	--







Systemsteckdosen:
steckbar oder mit Kabel
zu verbinden



 Flip-up Box 3-fach 2xSchuko 1xCustom KEB.338.0203-912.003 286 €	 Flip-up Box 6-fach 4xSchuko 2xCustom KEB.338.0205-912.007 316 €	 3-fach Steckdose steckbar KEB.336.600 22 €	 Schuko Anfang 5m KEB.375.007 24 €	 Verbindung 2m KEB.375.038 17 €	 Verbindung 3m KEB.375.055 19 €
---	---	--	---	---	---





Gesundheit:
Abgeschirmte
Systemsteckdosen



 3-fach Steckdose geschirmt KE41-4707 71 €	 5-fach Steckdose geschirmt KE41-4843 75 €	 Schuko Zuleitung 5m KE41-5067 54 €	 Verbindung 3.5m KE41-5168 46 €	 Geräte Kabel PC 2m KE41-2806 29 €	 Geräte Kabel C5 2m KE41-3763 47 €
---	---	---	--	--	--

Vorteil: Vollständig
öffnender Deckel für
beidseitige Nutzung





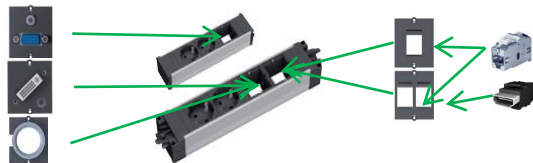

 Topframe 4-fach 2xSchuko 2xCustom KEB.925.000-909.003 587 €	 Topframe 8-fach 5xSchuko 3xCustom KEB.925.001-909.008 686 €	 Einfräsung in Tischplatte KEB.925.000e 63 €	 Klappe überfurniert KEB.925.000f 42 €		
---	---	--	---	--	--

Vorteil: Modulare
Stecksystem für Custom
module



 VGA + Miniklinke KEB.917.045 64 €	 DVI und Miniklinke KEB.917.021 149 €	 Tülle KEB.917.032 17 €
---	---	---

 Custom Modulplatte KEB.917.001 3 €	 Custom Modulplatte KEB.917.000 3 €	 Keystone RJ45 CAT6 KEB.940.044 30 €	 Keystone HDMI KEB.918.040 53 €	 Keystone USB 3.0A KEB.917.120 39 €	weitere Module und Einsätze auf Anfrage
---	---	--	--	---	--

Wählen Sie Gestell und Sichtblende

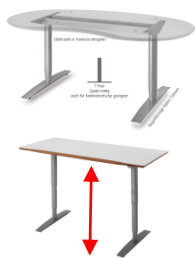









Traversenfreie T Steh-Sitz Gestelle RUND säulen Breite 1077 oder 1327 mm 	 Motorgestell T silber 1077/1327 *760x 645-1295 mm DDZRL2M-10/13-AL 1'399 €	 Motorgestell T chrom 1077/1327 *760x 645-1295 mm DDZRL2M-10/13-CR 2'455 €	Traversenfreie C Steh-Sitz Gestelle RECHTECK säulen Breite 1077 oder 1327 mm 	Auslaufend / Sonderpreis solange Vorrat  Motorgestell C silber 1077/1327x720-1220mm DDZRL1E-10/13-AL 600 €
	*Original LINAK Hubsäulen / Traverse mit Schacht für Motoren und Steuerung / 1077mm Breite bis Joker191 / 1327mm Breite ab Joker210			

	Memorytaster 138 €		DPT in Platte 157 €		Bluetooth Stick 138 €		PC Steuerung 138 €
---	-----------------------	---	------------------------	---	--------------------------	---	-----------------------

Vorteil: Kabel unter Tisch
werden verdeckt und die
Intimsphäre geschützt

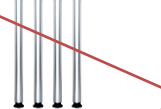
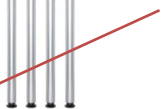

abnehmbare gebogene Blenden mit/ohne Edelstahlabdeckung BxH: mit V2A Abdeckung vitAcoustic PET OHNE V2A Abdeckung vitAcoustic PET mit V2A Abdeckung	 Plexiglas satina 1100 x 248mm 8dpp11022-PXS 302 €	 Akustik PET 1100 x 248mm 8dpp11022-PET 90 €	 Plexiglas satina 1257 x 405mm 8dpp12540-PXS 317 €	 Akustik PET 1257 x 405mm 8dpp12540-PET 144 €	 Softprotection bedruckt Mehrpreis +264 €
	 Fuß alufarben 9006 ø55 x 680-760mm bcb100--f-AL 64 €	 Fuß anthrazit 7021 ø55 x 680-760mm bcb100--f-AC 64 €	 Fuß HGchrom ø55 x 680-760mm bcb100--f-CR 64 €	 Fuß Mattchrom ø55 x 680-760mm bcb100--f-CM 64 €	Traversenfreie T Steh-Sitz Gestelle RECHTECK säulen Breite 1200-1800mm NEU in 2020!  Motorgestell T silber 1200-1800x645-1295 DDZRL2E-1218-AL 765 €
Zulage Fuss kürzen für Container: BCB100-ZCO		50 €			



Hochwertige FüÙe aus
Präzisionsrohr mit
eingelassener
Flanschplatte



***** Für 20mm Platten Stabilität prüfen und ggf. weitere FüÙe einplanen! FüÙe sind bei 20mm nicht eingelassen!**

abnehmbare Sichtblende
aus Holz passend zu
Einzelfußgestell

Sichtblende / Protection	für Joker 146 + 168: 8d1b-pw 565x600mm 197 €	für Joker 146 + 168: 8d2b-pw 900x600mm 228 €	abnehmbare Sichtblende aus Holz passend für alle Gestelle  8dpw11022 1100x220mm 123 € 212 € 321 € 326 €	
	19mm Melamin	197 €		228 €
	19mm Laminat*	275 €		328 €
	19mm Furnier	384 €		461 €
	Bambus 20mm	318 €		446 €

A-Fuss Gestell mit Kabelkanal und Lochblechblende für Plattentiefe >=800mm:	Auslaufend / Sonderpreis solange Vorrat  A-Fuss weiß/chrom 1155x710-805mm DF106-11-WC 201 €	Auslaufend / Sonderpreis solange Vorrat  A-Fuss schwarz/chrom 1155x710-805mm DF106-11-SC 201 €	Aluminium T-Fussgestell mit Kabelwanne für Plattentiefe >=800mm:	Auslaufend / Sonderpreis solange Vorrat  Alu-T schwarz/chrom 1155x720-930mm DF188-11-SC 245 €

Gestelle c-style

Säulenfüße mit Flachbodenplatte auch für Schreibtische



Wählen Sie Gestell und Sichtblende

Säulenfußgestelle mit Bodenplatte Größenempfehlung	146 2 Säulen mit Bodenplatte 450	168 2 Säulen mit Bodenplatte 450	191 2 Säulen mit Bodenplatte 520	210 2 Säulen mit Bodenplatte 675	231 2 Säulen mit Bodenplatte 675
Säulenfußgestelle mit Bodenplatte Größenempfehlung	450 2 Säulen mit Bodenplatte 450			210 2 Säulen mit Bodenplatte A10N	231 2 Säulen mit Bodenplatte A10N

*** MATT CHROM ist nicht mehr lieferbar!!!



Säulenfußgestelle (ohne Bodenplatte) Säule HG chrom oder Alufarben Steh- Sitz höhenverstellung mit Gasfeder und Fußauslöser	Säulenfuß ø90 h=713mm+Platte PTB.RFE-N75 AL (Alu) 153 €	Säulenfuß ø90 h=713mm+Platte PTB.RFE-N75 CR (Chrom) 283 €	Säulenfuß ø95 648-1063mm+Platte PTB.RFE-S CR/AL 635 €	702x634mm PTB.BPB10 AG/SW 292 €	750x500mm PTB.BPL11 AG/SW 261 €
--	--	--	--	---------------------------------------	---------------------------------------

Für Säulenfüße UND Motorgestelle (DDZRL2M)



Flach-Bodenplatte 8mm Graualuminium oder schwarz mit Filzgleiter für harte Böden	ø450mm PTB.BPR08 AG/SW 153 €	ø520mm PTB.BPR09 AG/SW 188 €	ø675mm PTB.BPR10 AG/SW 292 €	ø675x494mm PTB.BPA10N AG/SW 232 €	ø675x494mm PTB.BPA10N AG/SW 232 €
--	------------------------------------	------------------------------------	------------------------------------	---	---

Wählen Sie Tischbrücken / Thekenaufsätze



Tischbrücke mit Formteilblende in vitAcoustic PET	1245x316x230mm für alle Tischgrößen	124.5 cm x 31.6 cm x 23 cm	für 168 1438x371x230mm	für 191+210+231 1583x360x230mm	25mm Melamin	428 €	548 €	559 €
					25mm Laminat*	515 €	644 €	658 €

+Mindestmengenzuschlag für Laminat, Linoleum+Lack/Farbe+Auftrag: +120 €

25mm Furnier	585 €	707 €	726 €
Bambus 20mm	640 €	710 €	718 €

Wählen Sie geschlossene Unterbauten für Theke und Coffeebar







Geschlossener Unterbau mit Formteilverblendung	für Theken 750mm hoch OHNE Tischplatte	168	191	210	231
		H=750mm			
vitAcoustic PET / Innen Melamin		8d1b45-pj auf Anfrage	8d2b45-pj auf Anfrage	8d2b55-pj auf Anfrage	8d2b65-pj auf Anfrage



Geschlossener Unterbau mit Formteilverblendung	für Coffeebar 920mm hoch OHNE Tischplatte	168	191	210	231
		H=920mm			
vitAcoustic PET / Innen Melamin		8d1b45-pj-cbar auf Anfrage	8d2b45-pj-cbar auf Anfrage	8d2b55-pj-cbar auf Anfrage	8d2b65-pj-cbar auf Anfrage



Wählen Sie Caddy und Container

Rollcontainer mit Utensilienschieber, Zentralverschluss und Auszugssperre	 3 Schubladen + Utensilienschieber 456x600x555mm IBcr1233	 mit Hängekartei IBcr126	Schmalcontainer mit Utensilienschieber, Zentralverschluss und Auszugssperre	 3 Schubladen + Utensilienschieber 356x600x555mm IBcrs1233	 mit Hängekartei IBcrs126
---	---	---	---	--	--

Listenpreise UVP nach Preisgruppe

19mm Melamin	650 €	652 €	657 €	658 €
--------------	-------	-------	-------	-------

Teilefarbenmix: +60 € / Kantenfarbenmix: +50 € / +Mindestmengenzuschlag für Laminat, Linoleum+Lack/Farbe+Auftrag: +120 €

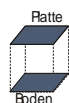



Platte oben:	Mehrpreise UVP nach Preisgruppe			
19mm Laminat	+68 €			+74 €
19mm Furnier	+178 €			+157 €
Bambus 20mm	+186 €		Sitzfläche Akustik PET	+161 €
Front	Mehrpreise UVP nach Preisgruppe			
19mm Laminat	+147 €	+121 €		+148 €
19mm Furnier	+418 €	+338 €		+390 €
Bambus 20mm	+395 €	+332 €		+363 €
Rückwand	Mehrpreise UVP nach Preisgruppe			
19mm Laminat	+61 €			+65 €
19mm Furnier	+163 €			+145 €
Bambus 20mm	+179 €			+151 €
Seiten (2 Stk):	Mehrpreise UVP nach Preisgruppe			
19mm Laminat	+272 €			+272 €
19mm Furnier	+516 €			+516 €
Bambus 20mm	+574 €			+574 €

Optionen für 456mm breite Container:	Trennsteg TSKA4 8.00 €	Formulargefache 5x 36.00 €	Optionen für 356mm breite Container:	Trennsteg TSKA4S 8.00 €
--------------------------------------	---------------------------	-------------------------------	--------------------------------------	----------------------------





Wählen Sie Option Softplatte für Container



Formplatte / Softplatte Mehrpreis	 VE-SP6655 559x666mm	 PT7A08G 810x720mm	 VE-SP6645 459x666mm
25mm MDF Melamin	242 €	316 €	217 €
25mm MDF Laminat*	335 €	450 €	296 €
Option Lackkante*	+238 €	+Mindestmengenzuschlag für Laminat, Linoleum+Lack/Farbe+Auftrag:	+120 €
25mm MDF Furnier	375 €	508 €	339 €
Bambus 20mm	375 €	512 €	318 €



Wählen Sie Caddy und Container

Langcontainer mit Utensilienschieber, Zentralverschluss und Auszugssperre			Kurzcontainer OHNE Utensilienschieber MIT Zentralverschluss und Auszugssperre		
	3 Schubladen + Utensilienschieber 456x800x555mm	mit Hängekartei		3 Schubladen mit Vollauszug 460x460x575mm	mit Hängekartei
	IBcu1233	IBcu126		IBcq333	IBcq36
19mm Melamin	726 €	745 €		687 €	584 €

Teilefarbenmix: +60 € / Kantenfarbenmix: +50 € / +Mindestmengenzuschlag für Laminat, Linoleum+Lack/Farbe+Auftrag: +120 €

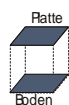





Platte oben:	Mehrpreise UVP nach Preisgruppe			*Platte oder Boden:	
19mm Laminat	84 €			63 €	
19mm Furnier	201 €		162 €		
Bambus 20mm	246 €		169 €		
Front	Mehrpreise UVP nach Preisgruppe				
19mm Laminat	147 €	121 €	117 €	91 €	
19mm Furnier	418 €	338 €	330 €	250 €	
Bambus 20mm	395 €	332 €	315 €	252 €	
Rückwand	Mehrpreise UVP nach Preisgruppe				
19mm Laminat	61 €		61 €		
19mm Furnier	163 €		163 €		
Bambus 20mm	179 €		179 €		
Seiten (2 Stk):	Mehrpreise UVP nach Preisgruppe				
19mm Laminat	330 €		248 €		
19mm Furnier	592 €		468 €		
Bambus 20mm	706 €		488 €		

Optionen für 456mm breite Container:	Trennsteg TSKA4 8 €	Formulargefache 8x 58 €
--------------------------------------	------------------------	----------------------------

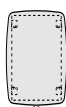



Trennsteg TSKA4 8 €

Wählen Sie Option Softplatte für Container



Formplatte / Softplatte Mehrpreis	 VE-SP9055 559x832mm		
25mm MDF Melamin	266 €	PT7A07 690x615mm	PT7o06G 659x624mm
25mm MDF Laminat*	368 €	255 €	255 €
		364 €	364 €
Option Lackkante*	+238 €	+Mindestmengenzuschlag für Laminat, Linoleum+Lack/Farbe+Auftrag: +120 €	
25mm MDF Furnier	425 €	404 €	404 €
Bambus 20mm	393 €	464 €	464 €

Wählen Sie Caddy und Container

 Caddy mit Ordnerfach, Utensilienschieber, Zentralverschluss und Auszugssperre	 4 Schubladen 456x600x1080mm CTcr12333	 mit Hängekartei 456x600x1080mm CTcr1236	Schmalcaddy mit Ordnerfach, Utensilienschieber, Zentralverschluss und Auszugssperre	 4 Schubladen 356x600x1080mm CTcrs12333	 mit Hängekartei 356x600x1080mm CTcrs1236
	19mm Melamin	908 €		910 €	905 €

Teilefarbenmix: +60 € / Kantenfarbenmix: +50 € / +Mindestmengenzuschlag für Laminat, Linoleum+Lack/Farbe+Auftrag: +120 €

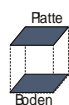



Platte oben:	Mehrpreise UVP nach Preisgruppe			
19mm Laminat	68 €			74 €
19mm Furnier	178 €			157 €
Bambus 20mm	186 €			161 €
Front	Mehrpreise UVP nach Preisgruppe			
19mm Laminat	186 €	160 €		188 €
19mm Furnier	528 €	448 €		492 €
Bambus 20mm	500 €	437 €		459 €
Rückwand	Mehrpreise UVP nach Preisgruppe			
19mm Laminat	103 €			115 €
19mm Furnier	254 €			219 €
Bambus 20mm	287 €			242 €
Seiten (2 Stk):	Mehrpreise UVP nach Preisgruppe			
19mm Laminat			470 €	
19mm Furnier			848 €	
Bambus 20mm			954 €	

Optionen für 456mm breite Container:	Trennsteg TSKA4 8 €	Formulargefache 5x 36 €	Optionen für 356mm breite Container:	Trennsteg TSKA4S 8 €
--------------------------------------	------------------------	----------------------------	--------------------------------------	-------------------------

Wählen Sie Option Softplatte für Container

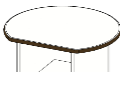
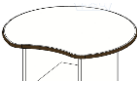





Formplatte / Softplatte Mehrpreis	 VE-SP6655 559x666mm	 PT7A08G 810x720mm	 PT7A09 905x828mm	 VE-SP6645 459x666mm
25mm MDF Melamin	242 €	316 €	383 €	217 €
25mm MDF Laminat*	335 €	450 €	517 €	296 €
Option Lackkante*	+238 €	+Mindestmengenzuschlag für Laminat, Linoleum+Lack/Farbe+Auftrag:		+120 €
25mm MDF Furnier	375 €	508 €	603 €	339 €
Bambus 20mm	375 €	512 €	535 €	318 €

square caddy 460



Wählen Sie Caddy und Container

Quadratischer Caddy modular einsetzbar: Z.B. als Block oder Nebeneinander als Sideboardersatz					
	CTcqo7o3o7	CTcqo7s3o7	CTcqo7s333	CTcqo7s36	
19mm Melamin	413 €	594 €	810 €	707 €	

Teilefarbenmix: +60 € / Kantenfarbenmix: +50 € / +Mindestmengenzuschlag für Laminat, Linoleum+Lack/Farbe+Auftrag: +120 €

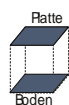

Platte oder Boden:	Mehrpreise UVP nach Preisgruppe		
19mm Laminat			63 €
19mm Furnier			162 €
Bambus 20mm			169 €



Front	Mehrpreise UVP nach Preisgruppe		
19mm Laminat	39 €	69 €	91 €
19mm Furnier	110 €	282 €	280 €
Bambus 20mm	105 €	267 €	294 €



Rückwand	Mehrpreise UVP nach Preisgruppe		
19mm Laminat			103 €
19mm Furnier			254 €
Bambus 20mm			287 €



Seiten (2 Stk):	Mehrpreise UVP nach Preisgruppe		
19mm Laminat			470 €
19mm Furnier			848 €
Bambus 20mm			954 €

Optionen für 456mm breite Container:	Trennsteg TSKA4 8 €
--------------------------------------	------------------------

Wählen Sie Option Softplatte für Container

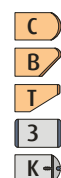





Formplatte / Softplatte Mehrpreis		
	PT7A07 690x615mm	PT7o06G 659x624mm
25mm MDF Melamin	255 €	255 €
25mm MDF Laminat*	364 €	364 €

Option Lackkante* +238 € +Mindestmengenzuschlag für Laminat, Linoleum+Lack/Farbe+Auftrag: +120 €

25mm MDF Furnier	404 €	404 €
Bambus 20mm	464 €	464 €

Vorteil: große Akustik Absorberfläche

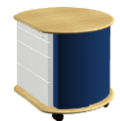

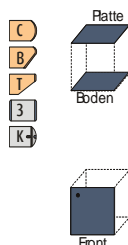

Wählen Sie Caddy und Container mit Mehrwert durch integrierte Akustikabsorber					
Rundcontainer mit Jalousieverblendung in vitAkustik PET	 3 Schubladen + Utensilienschieber 690x800x575mm IBcj0709-1233	 mit Hängekartei IBcj0709-126	Rund-Kurzcontainer OHNE Utensilienschieber 	 3 Schubladen mit Vollauszug 690x620x555mm IBcj07-333	 mit Hängekartei IBcj07-36
	19/25mm Melamin	1'351 €	1'343 €	1'350 €	1'247 €

Teilefarbenmix: +60 € / Kantenfarbenmix: +50 € / +Mindestmengenzuschlag für Laminat, Linoleum+Lack/Farbe+Auftrag: +120 €

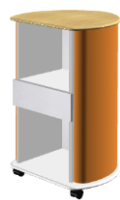

Platte oder Boden:	Mehrpreise UVP nach Preisgruppe			
25mm Laminat	326 €		310 €	
25mm Furnier	376 €		350 €	
Bambus 20mm	418 €		410 €	
Front	Mehrpreise UVP nach Preisgruppe			
19mm Laminat	147 €	121 €	156 €	130 €
19mm Furnier	418 €	338 €	440 €	360 €
Bambus 20mm	395 €	332 €	420 €	357 €

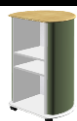
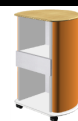

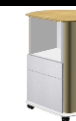
Wählen Sie Caddy und Container mit Mehrwert durch integrierte Akustikabsorber					
Kurzcaddy modular Rund Schubladen mit Vollauszug Jalousieverblendung in vitAkustik PET	 offen CTcvo7o3o7	 mit 1 Schublade CTcvo7s3o7	 mit 3 Schubladen 609x595x984mm CTcvo7s333	 mit Hängekartei CTcvo7s36	Ergänzung: 2 Schubladen oben CTcq-s33b
	19/25mm Melamin	1'067 €	1'248 €	1'464 €	1'361 €





Teilefarbenmix: +60 € / Kantenfarbenmix: +50 € / +Mindestmengenzuschlag für Laminat, Linoleum+Lack/Farbe+Auftrag: +120 €

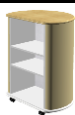

Platte oder Boden:	Mehrpreise UVP nach Preisgruppe			
19mm Laminat	203 €			
19mm Furnier	319 €			
Bambus 20mm	271 €			
Front	Mehrpreise UVP nach Preisgruppe			
19mm Laminat	39 €	69 €	117 €	78 €
19mm Furnier	110 €	282 €	360 €	220 €
Bambus 20mm	105 €	267 €	357 €	210 €
Rückwand	Mehrpreise UVP nach Preisgruppe			
19mm Laminat	103 €			
19mm Furnier	254 €			
Bambus 20mm	287 €			
Seiten (2 Stk):	Mehrpreise UVP nach Preisgruppe			
19mm Laminat	470 €			
19mm Furnier	848 €			
Bambus 20mm	954 €			

Optionen für 456mm breite Container:	Trennsteg TSKA4 8 €	Formulargefache 8x 58 €	Trennsteg TSKA4 8 €
--------------------------------------	------------------------	----------------------------	------------------------



Wählen Sie Caddy und Container mit Mehrwert durch integrierte Akustikabsorber					
Breitcaddy modular Rund Schubladen mit Vollauszug Jalousieverblendung in vitAkustik PET					
	offen	1 Schublade	Schublade+Türen	mit Hängekartei	Ergänzung: Türen oben
	CTcwo7o4o7	CTcwo7s4o7	CTcwo7s4d7	CTcwo7s46	CTcw-d7
19/25mm Melamin	1'231 €	1'639 €	1'796 €	2'057 €	203 €

Teilefarbenmix: +60 € / Kantenfarbenmix: +50 € / +Mindestmengenzuschlag für Laminat, Linoleum+Lack/Farbe+Auftrag: +120 €

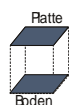

Platte oder Boden:	Mehrpreise UVP nach Preisgruppe			
19mm Laminat	283 €			
19mm Furnier	394 €			
Bambus 20mm	439 €			
Front	Mehrpreise UVP nach Preisgruppe			
19mm Laminat	51 €	106 €	168 €	117 €
19mm Furnier	137 €	340 €	402 €	265 €
Bambus 20mm	136 €	339 €	401 €	265 €
Rückwand	Mehrpreise UVP nach Preisgruppe			
19mm Laminat	134 €			
19mm Furnier	323 €			
Bambus 20mm	376 €			
Seiten (2 Stk):	Mehrpreise UVP nach Preisgruppe			
19mm Laminat	424 €			
19mm Furnier	754 €			
Bambus 20mm	908 €			

Optionen für 456mm breite Container:	Trennsteg TSKA4 8 €	Formulargefache 8x 58 €
--------------------------------------	------------------------	----------------------------

Trennsteg TSKA4 8 €



- Wählen Sie
- a) V-Fuge nach außen sichtbar als Gestaltungselement oder
 - b) V-Fuge nach innen unsichtbar und glatter Aussenseite.

Wählen Sie Caddy und Container

Hochcontainer mit durchgehender Front, dahinter 3 Schubladen, 1x 5HE für Utensilien und 2x 7HE für Ordner oder Hängekartei		3 Schubladen 456x800x1182mm CTcuh377			
19mm Melamin	1'137 €				

Teilefarbenmix: +60 € / Kantenfarbenmix: +50 € / +Mindestmengenzuschlag für Laminat, Linoleum+Lack/Farbe+Auftrag: +120 €

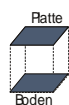





Platte oben:	Mehrpreise UVP nach Preisgruppe			
19mm Laminat	145 €			
19mm Furnier	243 €			
Bambus 20mm	264 €			
Front	Mehrpreise UVP nach Preisgruppe			
19mm Laminat	108 €			
19mm Furnier	268 €			
Bambus 20mm	294 €			
Rückwand	Mehrpreise UVP nach Preisgruppe			
19mm Laminat	108 €			
19mm Furnier	268 €			
Bambus 20mm	294 €			
Seiten (2 Stk):	Mehrpreise UVP nach Preisgruppe			
19mm Laminat		622 €		
19mm Furnier		1'068 €		
Bambus 20mm		1'470 €		

Optionen für 456mm breite Container:	Trennsteg TSKA4 8 €	Formulargefache 5x 36 €		
--------------------------------------	------------------------	----------------------------	--	--

Wählen Sie Anstell- und Besprechungstischplatten in Form und Größe

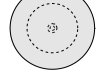

(*) Variante pt7a09 i08 = Innenrundung 08 passend für 8d1 Tische

Tischplatten mit Profilkante					
	Apple pt7a08 810x696mm	Apple pt7a09 (*) 905x828mm	Ronde pt7r11 1100x1100mm	Brecky pt7by09 962x894mm	pt7b4506 1299x691mm
25mm MDF Melamin	301 €	383 €	539 €	383 €	392 €
25mm MDF Laminat*	429 €	517 €	687 €	517 €	553 €
25mm MDF Furnier	474 €	603 €	794 €	603 €	614 €
Bambus 20mm	500 €	535 €	691 €	535 €	824 €





Option Lackkante*

+238 €

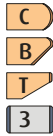
+Mindestmengenzuschlag für Laminat, Linoleum+Lack/Farbe+Auftrag:

+120 €

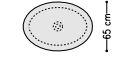

Tischplatten mit Profilkante					
	Ronde pt7r08 810x810mm	Ronde pt7r09 905x905mm	Ronde pt7r12 1240x1240mm	Brecky pt7by10 1102x1034mm	Ellipse pt7i09 900x650mm
25mm MDF Melamin	332 €	415 €	614 €	557 €	301 €
25mm MDF Laminat*	471 €	565 €	793 €	712 €	
25mm MDF Furnier	543 €	666 €	972 €	835 €	474 €
Bambus 20mm	523 €	563 €		705 €	500 €





Option Lackkante*

+238 €

+Mindestmengenzuschlag für Laminat, Linoleum+Lack/Farbe+Auftrag:

+120 €

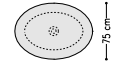

Tischplatten mit Profilkante					
	AppleG pt7r08g 810x690mm	Konkav pt7k10 920x920mm	Triangle pt7ta10 1000x995mm	Triplejoin 8d2tdj 1116x989mm	Ellipse pt7i10 1000x750mm
25mm MDF Melamin	301 €	415 €	415 €	449 €	367 €
25mm MDF Laminat*	429 €	565 €	565 €	637 €	495 €
25mm MDF Furnier	474 €	666 €	666 €	743 €	565 €
Bambus 20mm	500 €	563 €	563 €	706 €	523 €



Option Lackkante*

+238 €

+Mindestmengenzuschlag für Laminat, Linoleum+Lack/Farbe+Auftrag:

+120 €

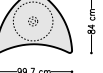

Tischplatten mit Profilkante					
	Ronde pt7r07 690x690mm	Triangle pt7t10 997x840mm	Quadro pt7q08 800x800mm		Ellipse pt7i11 1100x850mm
25mm MDF Melamin	255 €	383 €	332 €		399 €
25mm MDF Laminat*	364 €	517 €	471 €		565 €
25mm MDF Furnier	404 €	603 €	543 €		638 €
Bambus 20mm	464 €	535 €	523 €		665 €

Option Lackkante*

+238 €

+Mindestmengenzuschlag für Laminat, Linoleum+Lack/Farbe+Auftrag:





+120 €



Empfehlung Bodenplatte	1 Säule mit Bodenplatte 450	1 Säule mit Bodenplatte 520	1 Säule mit Bodenplatte 675	1 Säule mit Bodenplatte by10	1 Säule mit Bodenplatte 111
------------------------	--------------------------------	--------------------------------	--------------------------------	---------------------------------	--------------------------------

C
B
T
3

Wählen Sie Anstell- und Besprechungstischplatten in Form und Größe

Tischplatten mit Profilkante	 48 cm	 60 cm	 41,6 cm 69 cm	 80,2 cm 90,3 cm	
Ronde pt7r05 480x480mm	Ronde pt7r06 600x600mm	AppleG pt7r07g 690x620mm	Triplejoin 8d1tdj 903x802mm		
25mm MDF Melamin	172 €	211 €	255 €	383 €	
25mm MDF Laminat*	232 €	280 €	364 €	517 €	
25mm MDF Furnier	280 €	338 €	404 €	603 €	
Bambus 20mm	231 €	278 €	464 €	535 €	

Option Lackkante*

+238 €





+Mindestmengenzuschlag für Laminat, Linoleum+Lack/Farbe+Auftrag:

+120 €



Empfehlung Bodenplatte	1 Säule mit Bodenplatte 450	1 Säule mit Bodenplatte 450	1 Säule mit Bodenplatte 450	1 Säule mit Bodenplatte 450	



Wählen Sie Gestelle für varitable

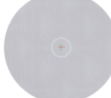

Säulenfußgestelle (ohne Bodenplatte) Säule HG chrom oder Alufarben Steh- Sitz höhenverstellung mit Gasfeder und Fußauslöser	 Säulenfuß ø90 h=713mm+Platte PTB.RFE-N75 AL (Alu)	 Säulenfuß ø90 h=713mm+Platte PTB.RFE-N75 CR (Chrom)	 Säulenfuß ø95 648-1063mm+Platte PTB.RFE-S CR/AL	 702x634mm PTB.BPB10 AG/SW	 750x500mm PTB.BPL11 AG/SW
	153 €	283 €	635 €	292 €	261 €



Flach-Bodenplatte 8mm Graualuminium oder schwarz mit Filzgleiter für harte Böden	 ø450mm PTB.BPR08 AG/SW	 ø520mm PTB.BPR09 AG/SW	 ø675mm PTB.BPR10 AG/SW	 ø675x494mm PTB.BPA10N AG/SW	
	153 €	188 €	292 €	232 €	

Alternativ Einzelfüße, je nach Plattenform und Größe sind 3,4 oder mehr Füße erforderlich. ø55 x 680-760mm	 Fuß alufarben 9006 ø55 x 680-760mm bcb100--f-AL	 Fuß anthrazit 7021 ø55 x 680-760mm bcb100--f-AC	 Fuß HG Chrom ø55 x 680-760mm bcb100--f-CR		
		64 €	64 €		



Das Universalgenie im Konferenz- und Schulungsbereich. Schneller und flexibler kann man Räume nicht umgestalten



Wählen Sie Schulungstischplatten in Form und Größe

Tischplatten mit Profilkante					
	pt7v1407r08 1391x690mm	pt7v1607r08 1554x690mm	pt7v1907r08 1928x690mm	pt7v2407r08 2403x690mm	AppleG pt7r08g 810x690mm
25mm MDF Melamin	406 €	540 €	596 €	652 €	301 €
25mm MDF Laminat*	623 €	734 €	808 €	1'035 €	429 €
25mm MDF Furnier	642 €	774 €	889 €	1'004 €	474 €
Bambus 20mm	834 €	855 €	896 €	1'174 €	500 €

Option Lackkante* +238 € +Mindestmengenzuschlag für Laminat, Linoleum+Lack/Farbe+Auftrag: +120 €

Tischplatten mit Profilkante					
	pt7e14r08 1340x704mm	pt7e14gr08 1340x666mm	pt7e18r08 1877x811mm	pt7e18gr08 1877x765mm	pt7e21i9 2100x793mm
25mm MDF Melamin	406 €	406 €	607 €	607 €	637 €
25mm MDF Laminat*	623 €	623 €	826 €	826 €	
25mm MDF Furnier	642 €	642 €	927 €	927 €	991 €
Bambus 20mm	834 €	834 €	906 €	906 €	1'164 €

Option Lackkante* +238 € +Mindestmengenzuschlag für Laminat, Linoleum+Lack/Farbe+Auftrag: +120 €

Wählen Sie Gestelle für flexiconference



	Klapptischgestell für ca. 1400mm Breite	Klapptischgestell für ca. 1600mm Breite		Klapptischgestell für ca. 1800mm Breite	Klapptischgestell für ca. 2000mm Breite
	Alufarben	1050x600mm		1250x600mm	Alufarben
bcbft2-10		bcbft2-12	bcbft2-14	bcbft2-16	
762 €		779 €	796 €	812 €	
Sichtblende transluzent		Sichtblende transluzent			
bcbft2-10-MP		bcbft2-12-MP	bcbft2-14-MP	bcbft2-16-MP	
160 €		171 €	197 €	237 €	

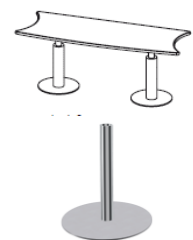

Säulenfußgestelle (ohne Bodenplatte) Säule HG chrom oder Alufarben Steh- Sitz höhenverstellung mit Gasfeder und Fußauslöser				Flach-Bodenplatte 8mm Graualuminium oder schwarz mit Filzgleiter für harte Böden	
	Säulenfuß ø90 h=713mm+Platte PTB.RFE-N75 AL (Alu)	Säulenfuß ø90 h=713mm+Platte PTB.RFE-N75 CR (Chrom)	Säulenfuß ø95 648-1063mm+Platte PTB.RFE-S CR/AL		ø450mm PTB.BPR08 AG/SW
153 €	283 €	635 €	153 €		

*** MATT CHROM ist nicht mehr lieferbar!!!!

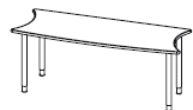

Alternativ Einzelfüße, je nach Plattenform und Größe sind 3,4 oder mehr Füße erforderlich. ø55 x 680-760mm					
	Fuß alufarben 9006 ø55 x 680-760mm bcb100--f-AL	Fuß anthrazit 7021 ø55 x 680-760mm bcb100--f-AC	Fuß HG chrom ø55 x 680-760mm bcb100--f-CH		
64 €	64 €	65'652 €			

Wählen Sie Konferenz- und Besprechungstischplatten in Form und Größe



C
B
T
3

Tischplatten Oval mit Profilkante					
	Oval pt7o1208 1265x810mm	Oval pt7o1710 1700x1029mm	Oval pt7o1911 1910x1100mm	Oval pt7o2512 2550x1240mm	Rund pt7qr0812 800x1240mm
25mm MDF Melamin	431 €	856 €	910 €	1'084 €	430 €
25mm MDF Laminat*	608 €	1'033 €	1'109 €	1'509 €	542 €
25mm MDF Furnier	709 €	1'189 €	1'314 €	1'743 €	651 €
Bambus 20mm	853 €	1'173 €	1'214 €		527 €

Option Lackkante*

+238 €

+Mindestmengenzuschlag für Laminat, Linoleum+Lack/Farbe+Auftrag:

+120 €



C
B
T
3

Tischplatten Ellipse mit Profilkante					
	Ellipse pt7e1710 1690x1029mm	Ellipse pt7e1810 1750x1030mm	Ellipse pt7e2111 2120x1110mm	Ellipse pt7e2412 2400x1240mm	Ellipse pt7e2612 2600x1240mm
25mm MDF Melamin	856 €	874 €	974 €	1'013 €	1'084 €
25mm MDF Laminat*	1'033 €	1'058 €	1'352 €	1'406 €	
25mm MDF Furnier	1'189 €	1'230 €	1'474 €	1'564 €	1'743 €
Bambus 20mm	1'173 €	1'187 €	1'263 €	1'292 €	

Option Lackkante*

+238 €

+Mindestmengenzuschlag für Laminat, Linoleum+Lack/Farbe+Auftrag:

+120 €

Empfehlung Bodenplatte	Säulen mit Bodenplatte 450	Säulen mit Bodenplatte 520	Säulen mit Bodenplatte 675
------------------------	----------------------------	----------------------------	----------------------------



C
B
T
3

kombinierbare Tischplatten Oval mit Profilkante					
	Oval pt7o2512h 1275x1240mm	Erweiterung pt7q0712 695x1240mm	Erweiterung pt7q0912 866x1240mm	Erweiterung pt7q1212 1240x1240mm	Erweiterung pt7q1712 1732x1240mm
25mm MDF Melamin	594 €	376 €	449 €	594 €	898 €
25mm MDF Laminat*	765 €	491 €	584 €	765 €	1'094 €
25mm MDF Furnier	924 €	582 €	696 €	924 €	1'294 €
Bambus 20mm	1'133 €	513 €	675 €	1'133 €	1'206 €

Option Lackkante*

+238 €

+Mindestmengenzuschlag für Laminat, Linoleum+Lack/Farbe+Auftrag:

+120 €



C
B
T
3

kombinierbare Tischplatten Ellipse mit Profilkante					
	Ellipse pt7e2612h 1300x1240mm	Erweiterung pt7q0712 695x1240mm	Erweiterung pt7q0912 866x1240mm	Erweiterung pt7q1212 1240x1240mm	Erweiterung pt7q1712 1732x1240mm
25mm MDF Melamin	594 €	376 €	449 €	594 €	898 €
25mm MDF Laminat*	765 €	491 €	584 €	765 €	1'094 €
25mm MDF Furnier	924 €	582 €	696 €	924 €	1'294 €
Bambus 20mm	1'133 €	513 €	675 €	1'133 €	1'206 €

Option Lackkante*

+238 €

+Mindestmengenzuschlag für Laminat, Linoleum+Lack/Farbe+Auftrag:

+120 €

Empfehlung Bodenplatte	Säulen mit Bodenplatte 675
------------------------	----------------------------



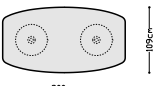
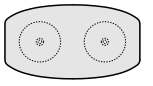
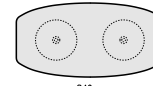
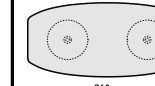
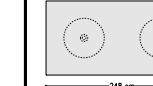

Wählen Sie Konferenz- und Besprechungstischplatten in Form und Größe

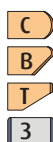

Tischplatten Boot mit Profilkanten	 Boot pt7f2011 2000x1090mm	 Boot pt7f2212 2200x1240mm	 Boot pt7f2412 2400x1240mm	 Boot pt7f2612 2600x1240mm	 Rund pt7q2412 2480x1240mm
25mm MDF Melamin	910 €	974 €	1'013 €	1'084 €	1'032 €
25mm MDF Laminat*	1'109 €	1'352 €	1'406 €	1'509 €	1'433 €
25mm MDF Furnier	1'314 €	1'474 €	1'564 €	1'743 €	1'609 €
Bambus 20mm	1'214 €	1'263 €	1'292 €		

Option Lackkante* +238 € +Mindestmengenzuschlag für Laminat, Linoleum+Lack/Farbe+Auftrag: +120 €





kombinierbare Tischplatten Boot mit Profilkanten	 Boot pt7f2612h 1300x1240mm	 Erweiterung pt7q0712 695x1240mm	 Erweiterung pt7q0912 866x1240mm	 Erweiterung pt7q1212 1240x1240mm	 Erweiterung pt7q1712 1732x1240mm
25mm MDF Melamin	594 €	376 €	449 €	594 €	898 €
25mm MDF Laminat*	765 €	491 €	584 €	765 €	1'094 €
25mm MDF Furnier	924 €	582 €	696 €	924 €	1'294 €
Bambus 20mm	1'133 €	513 €	675 €	1'133 €	1'206 €

Option Lackkante* +238 € +Mindestmengenzuschlag für Laminat, Linoleum+Lack/Farbe+Auftrag: +120 €



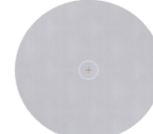

Empfehlung Bodenplatte	Säulen mit Bodenplatte 675
------------------------	----------------------------

Wählen Sie Gestelle für Konferenz und Besprechungstischplatten



Säulenfußgestelle (ohne Bodenplatte) Säule HG chrom oder Alufarben Steh- Sitz höhenverstellung mit Gasfeder und Fußauslöser	 Säulenfuß ø90 h=713mm+Platte PTB.RFE-N75 CR/AL	 Säulenfuß ø95 648-1063mm+Platte PTB.RFE-S CR/AL	Flach-Bodenplatte 8mm Graualuminium oder schwarz mit Filzgleiter für harte Böden	 ø675mm PTB.BPR10 AG/SW	Für die Erweiterungen sind Plattenverbinder erforderlich. Empfehlenswert sind 2 Stk pro 1m Fuge.
	153 €	635 €			

*** MATT CHROM ist nicht mehr lieferbar!!!!

Alternativ Einzelfüße, je nach Plattenform und Größe sind 3,4 oder mehr Füße erforderlich. ø55 x 680-760mm	 Fuß alufarben 9006 ø55 x 680-760mm bcb100--f-AL	 Fuß anthrazit 7021 ø55 x 680-760mm bcb100--f-AC	 Fuß Gchrom ø55 x 680-760mm bcb100--f-CP	 Verbinder Stahl (1Stk) bcb050s
	64 €	64 €	65'652 €	

Wählen Sie Konferenz- und Besprechungstischplatten in Form und Größe

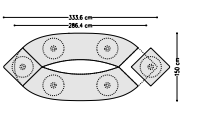
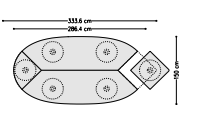
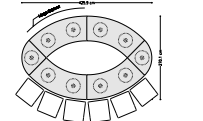
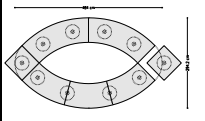
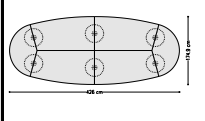

- C
- B
- T
- 3

Flexicon Set wahlweise mit runden oder quadratischen Endplatten					
	Kset pt7ks3415q	Kset pt7ks3415g	Kset pt7ks4327	Kset pt7ks4829	Kset pt7ks4318
	2864/3336x1500mm		4259x2701mm	4840x2942mm	4260x1729mm
25mm MDF Melamin	1'816 €		3'434 €	3'638 €	3'148 €
25mm MDF Laminat*	2'760 €		5'328 €	5'608 €	4'438 €
25mm MDF Furnier	2'914 €		5'600 €	6'064 €	4'836 €
Bambus 20mm	2'950 €		5'858 €	6'010 €	5'224 €
Option Lackkante*	+238 €		+Mindestmengenzuschlag für Laminat, Linoleum+Lack/Farbe+Auftrag:		+120 €
Empfehlung Bodenplatte	Bodenplatten 6x450	Bodenplatten 6x450	Bodenplatten 10x450	Bodenplatten 10x450	Bodenplatten 6x520

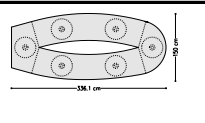
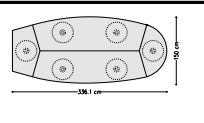
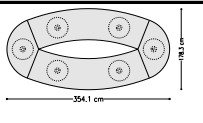
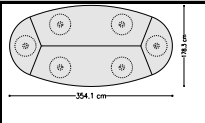
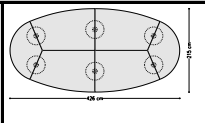

Flexicon Set wahlweise mit runden oder geraden Endplatten					
	Kset pt7ks3415	Kset pt7ks3415g	Kset pt7ks3518	Kset pt7ks3518g	Kset pt7ks4322
	3361x1500mm		3361x1500mm		4260x2150
25mm MDF Melamin	2'044 €		2'274 €		4'560 €
25mm MDF Laminat*	3'064 €		3'444 €		5'684 €
25mm MDF Furnier	3'270 €		3'710 €		6'460 €
Option Lackkante*	+238 €		+Mindestmengenzuschlag für Laminat, Linoleum+Lack/Farbe+Auftrag:		+120 €
Empfehlung Bodenplatte Säule HG chrom oder Mattchrom	Bodenplatten 6x450	Bodenplatten 6x450	Bodenplatten 6x520	Bodenplatten 6x520	Bodenplatten 6x520

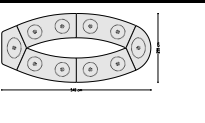
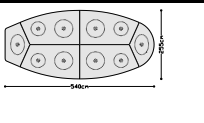
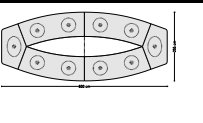
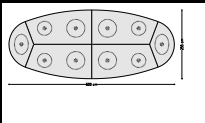
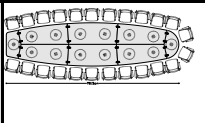

- C
- B
- T
- 3

Flexicon Set wahlweise mit runden oder geraden Endplatten					
	Kset pt7ks5425	Kset pt7ks5425g	Kset pt7ks6025	Kset pt7ks6025g	Kset pt7ks7018
	5400x2550mm		6000x2550mm		7015x1800mm
25mm MDF Melamin	4'100 €		5'456 €		4'640 €
25mm MDF Laminat*	6'232 €		7'564 €		7'218 €
25mm MDF Furnier	6'650 €		8'626 €		7'416 €
Bambus 20mm	6'742 €		7'980 €		
Option Lackkante*	+238 €		+Mindestmengenzuschlag für Laminat, Linoleum+Lack/Farbe+Auftrag:		+120 €
Empfehlung Bodenplatte	Bodenplatten 8x450+2xL11	Bodenplatten 8x520+2xL11	Bodenplatten 8x450+2xL11	Bodenplatten 8x520+2xL11	Bodenplatten 12x520+2xL11

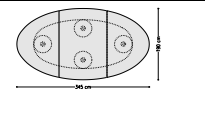
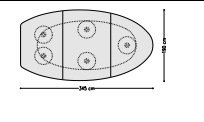
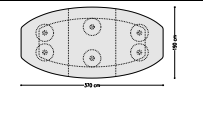
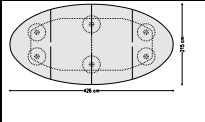
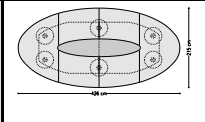

Konferenz Tischplatten mit Tragplatte					
	Ellipse pt7e3419 3450x1900mm	Ellipse+ pt7ef3519 3450x1900mm	Boot pt7f3719 3700x1900mm	Ellipse pt7e4222 4260x2150mm	mit Inlay pt7e4222i 4260x2150mm
25mm MDF Melamin	3'835 €		4'709 €	5'710 €	6'475 €
25mm MDF Laminat*	4'447 €		5'822 €	7'166 €	7'931 €
25mm MDF Furnier	5'101 €		6'131 €	7'514 €	8'279 €
Bambus 20mm	4'744 €		5'591 €	6'890 €	7'655 €
Option Lackkante*	+238 €		+Mindestmengenzuschlag für Laminat, Linoleum+Lack/Farbe+Auftrag:		+120 €
Empfehlung Bodenplatte	Bodenplatten 4x450	Bodenplatten 6x450	Bodenplatten 6x450	Bodenplatten 6x450	Bodenplatten 6x450

Wählen Sie Konferenz- und Besprechungstischplatten in Form und Größe

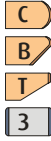

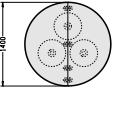
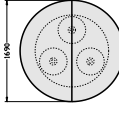
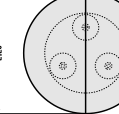
Runde Konferenz- und Besprechungstischplatten mit Tragplatte	 Ronde pt7r14g2 1400x1400mm	 Ronde pt7r17g2 1690x1690mm	 Ronde pt7r21g2 2120x2120mm
25mm MDF Melamin	1'388 €	1'776 €	2'755 €
25mm MDF Laminat*	1'822 €	2'216 €	3'483 €
25mm MDF Furnier	1'860 €	2'422 €	3'657 €
Bambus 20mm	2'244 €	2'378 €	3'345 €

Option Lackkante*

+238 €

+Mindestmengenzuschlag für Laminat, Linoleum+Lack/Farbe+Auftrag:

+120 €

Empfehlung Bodenplatte	3 Säulen mit Bodenplatte 450
------------------------	------------------------------

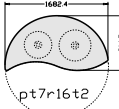
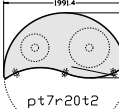
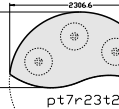

Flexicon modulare Tischplatten für Roundtable und Schulung.	 Ronde pt7r16t2 1682x915mm	 Ronde pt7r20t2 1991x1082mm	 Ronde pt7r23t2 2306x1257mm
25mm MDF Melamin	639 €	910 €	994 €
25mm MDF Laminat*	879 €	1'109 €	1'379 €
25mm MDF Furnier	1'008 €	1'314 €	1'519 €
Bambus 20mm	935 €	1'214 €	1'278 €

Option Lackkante*

+238 €





+Mindestmengenzuschlag für Laminat, Linoleum+Lack/Farbe+Auftrag:

+120 €

Empfehlung Bodenplatte	Bodenplatten 1x450 + 1x520	Bodenplatten 1x450 + 1x675	Bodenplatten 3x450
------------------------	-------------------------------	-------------------------------	-----------------------

Wählen Sie Gestelle für Konferenz und Besprechungstischplatten



Säulenfußgestelle (ohne Bodenplatte) Säule HG chrom oder Alufarben Steh- Sitz höhenverstellung mit Gasfeder und Fußauslöser	 Säulenfuß ø90 h=713mm+Platte PTB.RFE-N75 AL (Alu)	 Säulenfuß ø90 h=713mm+Platte PTB.RFE-N75 CR (Chrom)	 Säulenfuß ø95 648-1063mm+Platte PTB.RFE-S CR/AL	Für die Erweiterungen sind Plattenverbinder erforderlich. Empfehlenswert sind 2 Stk pro 1m Fuge.	 Verbinder Stahl (1Stk) bcb050s
	153 €	283 €	635 €		

*** MATT CHROM ist nicht mehr lieferbar!!!



Flach-Bodenplatte 8mm Graualuminium oder schwarz mit Filzgleiter für harte Böden	 ø450mm PTB.BPR08 AG/SW	 ø520mm PTB.BPR09 AG/SW	 ø675mm PTB.BPR10 AG/SW	 ø675x494mm PTB.BPA10N AG/SW
	153 €	188 €	292 €	232 €

Alternativ Einzelfüße, je nach Plattenform und Größe sind 3,4 oder mehr Füße erforderlich. ø55 x 680-760mm	 Fuß alufarben 9006 ø55 x 680-760mm bcb100--f-AL	 Fuß anthrazit 7021 ø55 x 680-760mm bcb100--f-AC	 Fuß 10-chrom ø55 x 680-760mm bcb100--f-CR
	64 €	64 €	65'652 €

Vorteil: große Akustik Absorberfläche

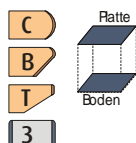
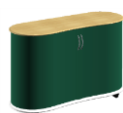

Wählen Sie Ihr Qiboard mit Mehrwert durch integrierte Akustikabsorber

Qiboard 10H Platte und Boden 25mm Formplatte mit Profil nach Wahl Rollladen in vitAkustik PET				
1300 / 10Ordnerhöhe 1300x467x384+s qib-1-013	1520 / 10Ordnerhöhe 1520x467x384+s qib-1-015	2150 / 10Ordnerhöhe 2150x467x384+s qib-1-021	e13 / 10Ordnerhöhe 1300x956+384+s qib-1-e13	
28/19mm Melamin	1'158 €	1'373 €	1'671 €	1'527 €
Qiboard 20H Platte und Boden 28mm Formplatte mit Profil nach Wahl				
1300 / 20Ordnerhöhen 1300x467x768+s qib-2-013	1520 / 20Ordnerhöhen 1520x467x768+s qib-2-015	2150 / 20Ordnerhöhen 2150x467x768+s qib-2-021	e13 / 20Ordnerhöhen 1300x956+768+s qib-2-e13	
28/19mm Melamin	1'462 €	1'691 €	2'202 €	1'880 €
Qiboard 30H Platte und Boden 28mm Formplatte mit Profil nach Wahl				
1300 / 30Ordnerhöhen 1300x467x1152+s qib-3-013	1520 / 30Ordnerhöhen 1520x467x1152+s qib-3-015	2150 / 30Ordnerhöhen 2150x467x1152+s qib-3-021	e13 / 30Ordnerhöhen 1300x956+1152+s qib-3-e13	
28/19mm Melamin	1'708 €	1'955 €	2'583 €	2'171 €

Option Lackkante*

+238 €

+Mindestmengenzuschlag für Laminat, Linoleum+Lack/Farbe+Auftrag:

+120 €

Platte oder Boden:	Mehrpreise UVP nach Preisgruppe			
25mm Laminat*	+319 €	+402 €	+549 €	+521 €
25mm Furnier	+392 €	+469 €	+581 €	+641 €
Bambus 20mm	+422 €	+421 €	+570 €	+744 €

Rückwand 10H	Mehrpreise UVP nach Preisgruppe				Innen (Seiten und Fachb.) = Standard Melamin
19mm Laminat	+89 €	+108 €	+143 €	+76 €	
19mm Furnier	+223 €	+268 €	+345 €	+193 €	
Bambus 20mm	+274 €	+294 €	+459 €	+215 €	
Rückwand 20H	Mehrpreise UVP nach Preisgruppe				Innen (Seiten und Fachb.) = Standard Melamin
19mm Laminat	+147 €	+185 €	+254 €	+124 €	
19mm Furnier	+330 €	+408 €	+539 €	+279 €	
Bambus 20mm	+463 €	+609 €	+816 €	+429 €	
Rückwand 30H	Mehrpreise UVP nach Preisgruppe				Innen (Seiten und Fachb.) = Standard Melamin
19mm Laminat	+185 €	+234 €	+323 €	+153 €	
19mm Furnier	+446 €	+557 €	+747 €	+371 €	
Bambus 20mm	+619 €	+653 €	+1'102 €	+462 €	

Hängerahmen	Mehrpreise UVP nach Preisgruppe			
	839mm 2xA4	1162mm 2xA4	839mm 2xA4	939mm 2xA4
	MHRQ08	MHRQ10	MHRQ08	MHRQ09
	+312 €	+337 €	+312 €	+337 €

Wählen Sie
a) V-Fuge
nach außen
sichtbar als
Gestaltungs
element
oder
b) Schnitt
ausen mit
glatter
gerader
Aussenseite.

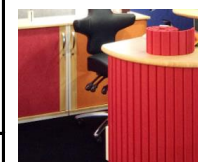

Raster Modulsystem	Alle Schranktypen (Querrolladen, Schiebe-, Flügeltür, Regal oder Kartei können individuell horizontal und vertikal im Raster kombiniert werden.
Ausführung	Dreischicht Feinspanplatten E1 DIN 68765 19mm beidseitig melaminharzbeschichtet. (Seiten, Boden und Front 19mm / Rückwand 8mm stark) 8mm Rückwände in weiß oder anthrazit. Andere Farben mit Aufpreis 19mm Sichtrückwand möglich. Farbmix zwischen Oberfläche und Kanten möglich (Mehrpreis). Fachböden aus 19 und ab 1000mm Breite 25/28mm stark.
	Hochwertige Schrankverbinder - Schränke sind bei Bedarf zerlegbar.
	Flügeltüren mit verdeckten Ganzmetallscharnieren, Öffnungswinkel 125 Grad autom. Zuhaltung, einstellbar und mit montagefreundlicher Klipstechnik. Ab 2008 sanftem Schließmechanismus Drehstangenschloß mit Wechselzylinder, sowie Griffe nach Wahl
	Schiebetüren mit Schloß und Wechselzylinder, sowie Griffe nach Wahl Querrolladen aus vitAcoustic PET mit Schloß und Griff
Sockel	Minisockel mit 25mm Bodenplatte und stabile, von innen verstellbare Sockelfüße ca. 5-20mm aus Metall
Optionen	Designvariationen der Platten, Sichtrückwände, Eckelemente, Dreholivenschlösser, Hängerahmen, uvm.
Sonder	Sondertiefe 637mm: +50%

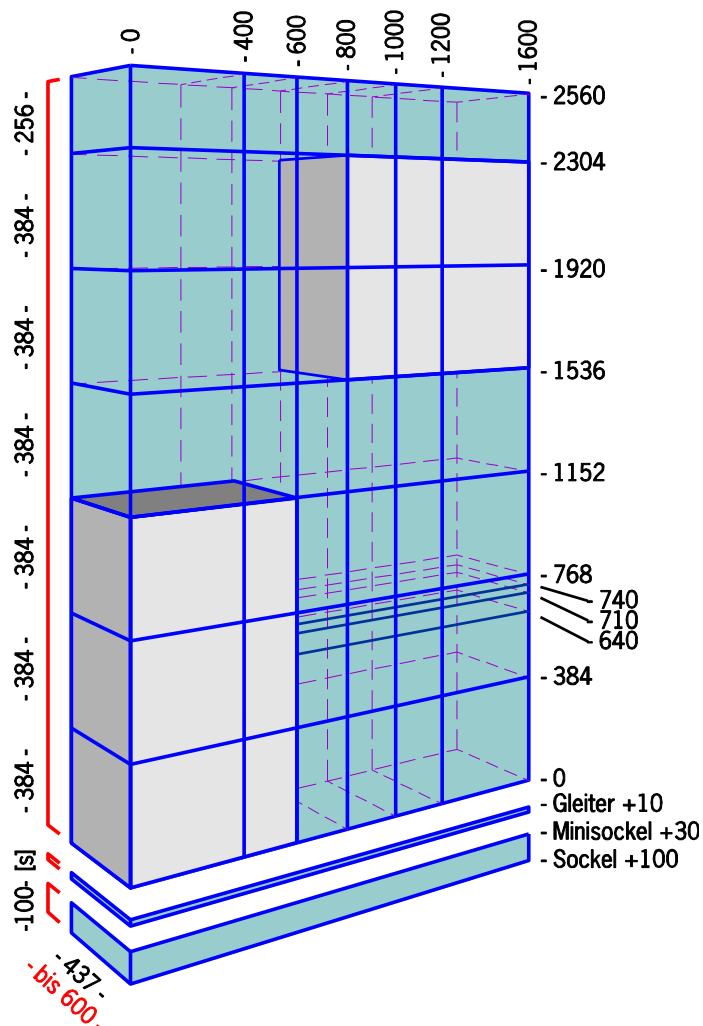









VORTEIL: Rolladenschränke mit Akustikabsorber reduzieren den Lärmpegel durch die großen Absorberflächen sehr effektiv.



Wählen Sie
a) V-Fuge nach außen sichtbar als Gestaltungselement oder
b) V-Fuge nach innen unsichtbar und glatter Aussenseite.

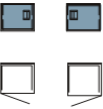
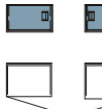

Wählen Sie Ihr Sideboard oder Schrank

offenes Regal 1 Ordnerhöhe					
	400x437x384+s ofo-1-004	600x437x384+s ofo-1-006	800x437x384+s ofo-1-008	1000x437x384+s ofo-1-010	1200x437x384+s ofo-1-012
19mm Melamin	142 €	166 €	187 €	207 €	264 €



Flügeltüren mit Schloss (Links oder Rechts angeschlagen)					
	ofd-1-004 L/R	ofd-1-006 L/R	ofd-1-008	ofd-1-010	ofd-1-012
19mm Melamin	227 €	259 €	350 €	378 €	443 €

Schiebetüren mit Schloss					
			ofs-1-008	ofs-1-010	ofs-1-012
19mm Melamin			350 €	378 €	443 €

(Mehr) Preise für Front oder Sichrückwand (1 Teil):

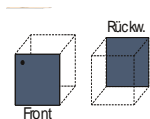

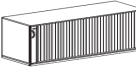
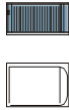
19mm Melamin(RW)	32 €	40 €	64 €	72 €	80 €
19mm Laminate	55 €	68 €	111 €	126 €	136 €
19mm Furnier	147 €	178 €	295 €	324 €	356 €
Bambus 20mm	150 €	186 €	301 €	338 €	372 €

Wählen Sie Rolladenschränke mit Mehrwert durch integrierte Akustikabsorber

Querrolladen mit Schloss (Standard= von links nach rechts öffnend) Rollladen vitAcoustic PET	MIT SEITEN LINKS UND RECHTS				
			ofr-1-008	ofr-1-010	ofr-1-012
19mm Melamin / Rollladen vitAcoustic PET			414 €	454 €	522 €

Teilefarbenmix: +60 € / Kantenfarbenmix: +50 € / +Mindestmengenzuschlag für Laminat, Linoleum+Lack/Farbe+Auftrag: +120 €

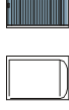

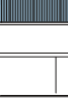

Querrolladen mit Schloss (Standard= von links nach rechts öffnend) Rollladen vitAcoustic PET	MIT nur 1 SEITE, Andere Seite = Rolladen sichtbar				
			ofr-1-008	ofr-1-010	ofr-1-012
19mm Melamin / Rollladen vitAcoustic PET			382 €	422 €	490 €



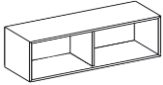
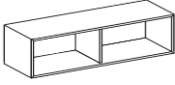

Teilefarbenmix: +60 € / Kantenfarbenmix: +50 € / +Mindestmengenzuschlag für Laminat, Linoleum+Lack/Farbe+Auftrag: +120 €

Gleiter s=10mm	+20 €	+20 €	+20 €	+20 €	+30 €
Minisockel s=+11mm	+52 €	+61 €	+68 €	+78 €	+94 €
Rollen s=60mm	+40 €	+40 €	+40 €	+40 €	+60 €
Aufsatz	bei Aufsatzschränken sind die Griffe unten montiert				

Wählen Sie Ihr Sideboard oder Schrank

offenes Regal 1 Ordnerhöhe					
	1600x437x384+s ofo-1-016	2000x437x384+s ofo-1-020		437x437x384+s ofo-1-0e4	437x437x384+s ofo-1-0r4
19mm Melamin	324 €	348 €		284 €	426 €

Flügeltüren mit Schloss (Links oder Rechts angeschlagen)					
19mm Melamin					



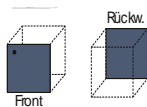

Schiebetüren mit Schloss					
					
	ofs-1-016	ofs-1-020			
19mm Melamin	515 €	551 €			

(Mehr) Preise für Front oder Sichtrückwand (1 Teil):





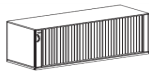

19mm Melamin(RW)	92 €	104 €
19mm Laminat	168 €	185 €
19mm Furnier	402 €	461 €
Bambus 20mm	492 €	521 €

Wählen Sie Rolladenschränke mit Mehrwert durch integrierte Akustikabsorber

Querrolladen mit Schloss (Standard=von links nach rechts öffnend) Rollladen vitAcoustic PET			MIT SEITEN LINKS UND RECHTS		
					
	ofr-1-016	ofr-1-020			
19mm Melamin / Rolllad	631 €	677 €			

Teilefarbenmix: +60 € / Kantenfarbenmix: +50 € / +Mindestmengenzuschlag für Laminat, Linoleum+Lack/Farbe+Auftrag: +120 €













Querrolladen mit Schloss (Standard=von links nach rechts öffnend) Rollladen vitAcoustic PET			MIT nur 1 SEITE, Andere Seite = Rolladen sichtbar		
					
	ofr-1-016	ofr-1-020			
19mm Melamin / Rolllad	599 €	645 €			



Teilefarbenmix: +60 € / Kantenfarbenmix: +50 € / +Mindestmengenzuschlag für Laminat, Linoleum+Lack/Farbe+Auftrag: +120 €

Minisockel s=+11mm	+117 €	+129 €		+52 €	+84 €
Rollen s=60mm	+60 €	+60 €		+40 €	+40 €
Aufsatz	bei Aufsatzschränken sind die Griffe unten montiert				

Wählen Sie Ihr Sideboard oder Schrank

offenes Regal 2 Ordnerhöhen					
	400x437x768+s ofo-2-004	600x437x768+s ofo-2-006	800x437x768+s ofo-2-008	1000x437x768+s ofo-2-010	1200x437x768+s ofo-2-012
19mm Melamin	218 €	257 €	294 €	348 €	430 €

Flügeltüren mit Schloss (Links oder Rechts angeschlagen)					
	ofd-2-004 L/R	ofd-2-006 L/R	ofd-2-008	ofd-2-010	ofd-2-012
19mm Melamin	333 €	386 €	489 €	555 €	653 €



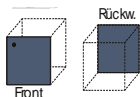

Schiebetüren mit Schloss					
			ofs-2-008	ofs-2-010	ofs-2-012
19mm Melamin			489 €	555 €	653 €

(Mehr) Preise für Front oder Sichtrückwand (1 Teil):

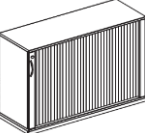

19mm Melamin(RW)	64 €	82 €	128 €	144 €	164 €
19mm Laminat	108 €	139 €	216 €	257 €	279 €
19mm Furnier	268 €	343 €	536 €	611 €	687 €
Bambus 20mm	294 €	384 €	588 €	745 €	769 €

Wählen Sie Rolladenschränke mit Mehrwert durch integrierte Akustikabsorber

Querrolladen mit Schloss (Standard=von links nach rechts öffnend) Rollladen vitAcoustic PET	MIT SEITEN LINKS UND RECHTS				
			ofr-2-008	ofr-2-010	ofr-2-012
19mm Melamin / Rollladen vitAcoustic PET			591 €	689 €	789 €



Teilefarbenmix: +60 € / Kantenfarbenmix: +50 € / +Mindestmengenzuschlag für Laminat, Linoleum+Lack/Farbe+Auftrag: +120 €





Querrolladen mit Schloss (Standard=von links nach rechts öffnend) Rollladen vitAcoustic PET	MIT nur 1 SEITE, Andere Seite = Rolladen sichtbar				
			ofr-2-008	ofr-2-010	ofr-2-012
19mm Melamin / Rollladen vitAcoustic PET			543 €	641 €	741 €

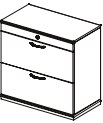



Teilefarbenmix: +60 € / Kantenfarbenmix: +50 € / +Mindestmengenzuschlag für Laminat, Linoleum+Lack/Farbe+Auftrag: +120 €

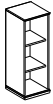
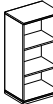

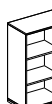
Minisockel s=+11mm	+52 €	+61 €	+68 €	+78 €	+94 €
Rollen s=60mm	+40 €	+40 €	+40 €	+40 €	+60 €
Aufsatz	bei Aufsatzschränken sind die Griffe unten montiert				

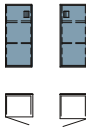
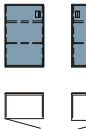
Karteischränke					
			ofk?-2-008 auf Anfrage	ofk?-2-010 auf Anfrage	
19mm Melamin					

Wählen Sie Ihr Sideboard oder Schrank

offenes Regal 3 Ordnerhöhen					
	400x437x1152+s ofo-3-004	600x437x1152+s ofo-3-006	800x437x1152+s ofo-3-008	1000x437x1152+s ofo-3-010	1200x437x1152+s ofo-3-012
19mm Melamin	292 €	346 €	398 €	439 €	592 €





Flügeltüren mit Schloss (Links oder Rechts angeschlagen)					
	ofd-3-004 L/R	ofd-3-006 L/R	ofd-3-008	ofd-3-010	ofd-3-012
19mm Melamin	423 €	495 €	625 €	682 €	855 €

Schiebetüren mit Schloss					
			ofs-3-008	ofs-3-010	ofs-3-012
19mm Melamin			625 €	682 €	855 €

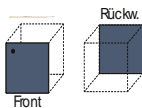
(Mehr) Preise für Front oder Sichtrückwand (1 Teil):

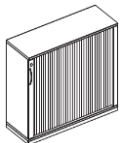



19mm Melamin(RW)	64 €	82 €	128 €	144 €	164 €
19mm Laminat	108 €	139 €	216 €	257 €	279 €
19mm Furnier	268 €	343 €	536 €	611 €	687 €

Wählen Sie Rolladenschränke mit Mehrwert durch integrierte Akustikabsorber

Querrolladen mit Schloss (Standard=von links nach rechts öffnend) Rollladen vitAcoustic PET	MIT SEITEN LINKS UND RECHTS				
			ofr-3-008	ofr-3-010	ofr-3-012
19mm Melamin / Rollladen vitAcoustic PET			770 €	861 €	1'038 €



Teilefarbenmix: +60 € / Kantenfarbenmix: +50 € / +Mindestmengenzuschlag für Laminat, Linoleum+Lack/Farbe+Auftrag: +120 €





Querrolladen mit Schloss (Standard=von links nach rechts öffnend) Rollladen vitAcoustic PET	MIT nur 1 SEITE, Andere Seite = Rollladen sichtbar				
			ofr-3-008	ofr-3-010	ofr-3-012
19mm Melamin / Rollladen vitAcoustic PET			706 €	797 €	974 €





Teilefarbenmix: +60 € / Kantenfarbenmix: +50 € / +Mindestmengenzuschlag für Laminat, Linoleum+Lack/Farbe+Auftrag: +120 €

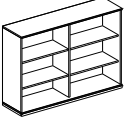
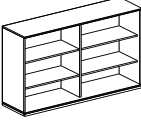

Minisockel s=+11mm	+52 €	+61 €	+68 €	+78 €	+94 €
Rollen s=60mm	+40 €	+40 €	+40 €	+40 €	+60 €
Aufsatz	bei Aufsatzschränken sind die Griffe unten montiert				

Karteischränke					
			ofk?-3-008	ofk?-3-010	
19mm Melamin			auf Anfrage	auf Anfrage	

Wählen Sie Ihr Sideboard oder Schrank

offenes Regal 3 Ordnerhöhen			offenes Eckregal 3 Ordnerhöhen		
	1600x437x1152+s ofo-3-016	2000x437x1152+s ofo-3-020		437x437x1152+s ofo-3-0e4	437x437x1152+s ofo-3-0r4
19mm Melamin	714 €	780 €		584 €	876 €

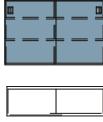
offenes Eckregal 4 Ordnerhöhen			offenes Eckregal 5 Ordnerhöhen		
	437x437x1536+s ofo-4-0e4	437x437x1536+s ofo-4-0r4		437x437x1920+s ofo-5-0e4	437x437x1920+s ofo-5-0r4
19mm Melamin	800 €	1'200 €		20'778 €	31'167 €

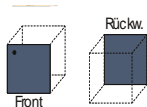

Schiebetüren mit Schloss			offenes Eckregal 6 Ordnerhöhen		
	ofs-3-016	ofs-3-020		437x437x1536+s ofo-6-0e4	437x437x1536+s ofo-6-0r4
19mm Melamin	1'007 €	1'095 €		1'010 €	1'515 €

(Mehr) Preise für Front oder Sichtrückwand (1 Teil):



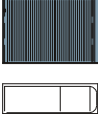

19mm Melamin(RW)	194 €	216 €
19mm Laminat	370 €	413 €
19mm Furnier	816 €	959 €

Wählen Sie Rolladenschränke mit Mehrwert durch integrierte Akustikabsorber

Querrolladen mit Schloss (Standard= von links nach rechts öffnend) Rollladen vitAcoustic PET		MIT Seiten LINKS UND RECHTS	offenes Eckregal 7 Ordnerhöhen		
	ofr-3-016			437x437x1920+s ofo-7-0e4	437x437x1920+s ofo-7-0r4
19mm Melamin / Rolllad	1'287 €			1'084 €	1'626 €

Teilefarbenmix: +60 € / Kantenfarbenmix: +50 € / +Mindestmengenzuschlag für Laminat, Linoleum+Lack/Farbe+Auftrag: +120 €

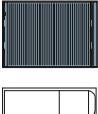





Querrolladen mit Schloss (Standard= von links nach rechts öffnend) Rollladen vitAcoustic PET		MIT nur 1 SEITE, Andere Seite = Rolladen sichtbar	offenes Eckregal 7 Ordnerhöhen		
	ofr-3-016			437x437x1920+s ofo-7-0e4	437x437x1920+s ofo-7-0r4
19mm Melamin / Rolllad	1'223 €			1'084 €	1'626 €

Teilefarbenmix: +60 € / Kantenfarbenmix: +50 € / +Mindestmengenzuschlag für Laminat, Linoleum+Lack/Farbe+Auftrag: +120 €

Minisockel s=+11mm	+117 €	+129 €		+52 €	+84 €
Rollen s=60mm	+60 €	+60 €		+40 €	+40 €
Aufsatz	bei Aufsatzschränken sind die Griffe unten montiert				

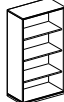
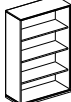
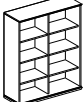
Wählen Sie Ihr Sideboard oder Schrank

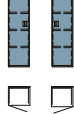
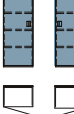

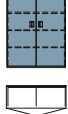
offenes Regal 4 Ordnerhöhen					
	400x437x1536+s ofo-4-004	600x437x1536+s ofo-4-006	800x437x1536+s ofo-4-008	1000x437x1536+s ofo-4-010	1200x437x1536+s ofo-4-012
19mm Melamin	400 €	485 €	572 €	615 €	847 €

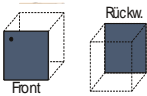

Flügeltüren mit Schloss (Links oder Rechts angeschlagen)					
	ofd-4-004 L/R	ofd-4-006 L/R	ofd-4-008	ofd-4-010	ofd-4-012
19mm Melamin	565 €	677 €	867 €	934 €	1'196 €

(Mehr) Preise für Front oder Sichtrückwand (1 Teil):

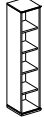
19mm Melamin(RW)	87 €	114 €	174 €	198 €	228 €
19mm Laminat	138 €	182 €	276 €	333 €	364 €
19mm Furnier	330 €	428 €	660 €	757 €	856 €

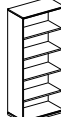
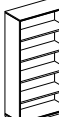
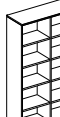

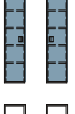
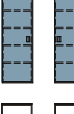
offenes Regal 5 Ordnerhöhen					
	400x437x1920+s ofo-5-004	600x437x1920+s ofo-5-006	800x437x1920+s ofo-5-008	1000x437x1920+s ofo-5-010	1200x437x1920+s ofo-5-012
19mm Melamin	10'389 €	547 €	638 €	695 €	959 €

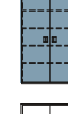
Flügeltüren mit Schloss (Links oder Rechts angeschlagen)					
	ofd-5-004 L/R	ofd-5-006 L/R	ofd-5-008	ofd-5-010	ofd-5-012
19mm Melamin	10'566 €	754 €	957 €	1'040 €	1'338 €



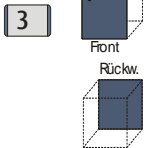

(Mehr) Preise für Front oder Sichtrückwand (1 Teil):





19mm Melamin(RW)	99 €	129 €	198 €	224 €	258 €
19mm Laminat	157 €	207 €	315 €	377 €	415 €
19mm Furnier	389 €	509 €	779 €	899 €	1'019 €

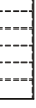
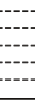

Minisockel s=+11mm	+52 €	+61 €	+68 €	+78 €	+94 €
Rollen s=60mm	+40 €	+40 €	+40 €	+40 €	+60 €
Aufsatz	bei Aufsatzschränken sind die Griffe unten montiert				

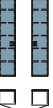
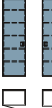
Wählen Sie Ihr Sideboard oder Schrank

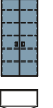
offenes Regal 6 Ordnerhöhen					
	400x437x2304+s ofo-6-004	600x437x2304+s ofo-6-006	800x437x2304+s ofo-6-008	1000x437x2304+s ofo-6-010	1200x437x2304+s ofo-6-012
19mm Melamin	505 €	606 €	702 €	772 €	1'068 €





Flügelüren mit Schloss (Links oder Rechts angeschlagen)					
	ofd-6-004 L/R	ofd-6-006 L/R	ofd-6-008	ofd-6-010	ofd-6-012
19mm Melamin	691 €	824 €	1'039 €	1'137 €	1'469 €



(Mehr) Preise für Front oder Sichtrückwand (1 Teil):

19mm Melamin(RW)	108 €	140 €	216 €	244 €	280 €
19mm Laminat	199 €	265 €	397 €	489 €	530 €
19mm Furnier	435 €	570 €	869 €	1'005 €	1'140 €

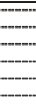
3

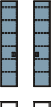
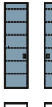
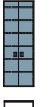

offenes Regal 7 Ordnerhöhen					
	400x437x2560+s ofo-7-004	600x437x2560+s ofo-7-006	800x437x2560+s ofo-7-008	1000x437x2560+s ofo-7-010	1200x437x2560+s ofo-7-012
19mm Melamin	542 €	651 €	754 €	836 €	1'156 €

Flügelüren mit Schloss (Links oder Rechts angeschlagen)					
	ofd-7-004 L/R	ofd-7-006 L/R	ofd-7-008	ofd-7-010	ofd-7-012
19mm Melamin	730 €	880 €	1'095 €	1'221 €	1'579 €

(Mehr) Preise für Front oder Sichtrückwand (1 Teil):

19mm Melamin(RW)	110 €	151 €	220 €	264 €	302 €
19mm Laminat	207 €	285 €	414 €	523 €	569 €
19mm Furnier	463 €	632 €	926 €	1'111 €	1'263 €

3



Minisockel s=+11mm	+52 €	+61 €	+68 €	+78 €	+94 €
Rollen s=60mm	+40 €	+40 €	+40 €	+40 €	+60 €
Aufsatz	bei Aufsatzschränken sind die Griffe unten montiert				

Wählen Sie Ihr Material und Ihre Oberfläche

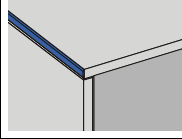
Mehrpreise Material und Oberfläche		Standardplatte mit geraden Kanten			
Platte oder Boden:	400mm	600mm	800mm	1000mm	1200mm

Mehrpreise für 1 Teil:

19mm Melamin	Standard				
19mm Laminat	+55 €	+69 €	+81 €	+94 €	+108 €
19mm Furnier	+147 €	+178 €	+208 €	+239 €	+268 €
Bambus 20mm	+150 €	+186 €	+222 €	+280 €	+294 €

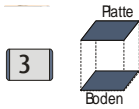

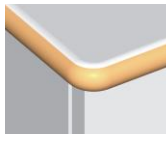

Mehrpreise Material und Oberfläche		Formplatte mit runden Ecken R=30mm Vorne, links und rechts um Profilstärke überstehend. C-Profil: seitlich 2x15mm und Vorne 25mm B+T-Profil: seitlich 2x30mm und Vorne 30mm			
Platte oder Boden:	400mm	600mm	800mm	1000mm	1200mm

Mehrpreise für 1 Teil:

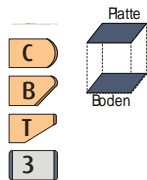
25mm Melamin	+102 €	+131 €	+159 €	+192 €	+212 €
25mm Laminat*	+117 €	+150 €	+179 €	+214 €	+241 €
25mm Furnier	+174 €	+217 €	+258 €	+304 €	+340 €
Bambus 20mm	+150 €	+186 €	+222 €	+280 €	+294 €

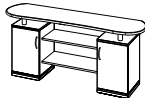
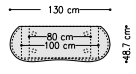
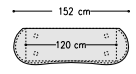
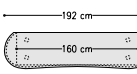

					
Formplatte	1300x487mm	1520x487mm	1920x487mm	Fuß nur aufliegend ø38x100h mm DX121	fest montierbarer Distanzfuss (1 Stk.) ø55x200h mm bcb120

Preise für 1 Teil OHNE DistanzfüÙe

25mm Melamin	300 €	390 €	462 €	+22 € chrom	+54 € chrom Mattchrom anthrazit
25mm Laminat*	409 €	519 €	688 €		
25mm Furnier	482 €	586 €	720 €		
Bambus 20mm	512 €	538 €	709 €		

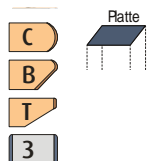
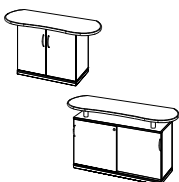

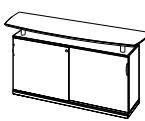
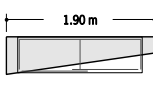
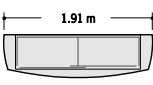
		
Formplatte	1910x460mm	1910x550mm

Preise für 1 Teil OHNE DistanzfüÙe

25mm Melamin		462 €	462 €
25mm Laminat*		688 €	688 €
25mm Furnier		720 €	720 €
Bambus 20mm		709 €	709 €

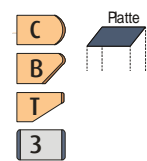
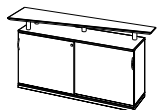

Wählen Sie Ihr Material und Ihre Oberfläche

Mehrpreise Material und Oberfläche		Standardplatte mit geraden Kanten			
------------------------------------	---	-----------------------------------	--	--	--

Platte oder Boden:	1600	2000			
---------------------------	------	------	--	--	--

Mehrpreise für 1 Teil:

19mm Melamin	Standard			
19mm Laminat	+138 €	+157 €		
19mm Furnier	+330 €	+389 €		
Bambus 20mm	+452 €	+480 €		

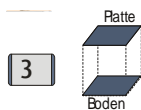

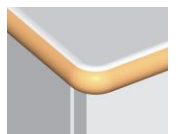



Mehrpreise Material und Oberfläche		Formplatte mit runden Ecken R=30mm Vorne, links und rechts um Profilstärke überstehend. C-Profil: seitlich 2x15mm und Vorne 25mm B+T-Profil: seitlich 2x30mm und Vorne 30mm			
------------------------------------	---	--	--	--	--

Platte oder Boden:	1600	2000			
---------------------------	------	------	--	--	--

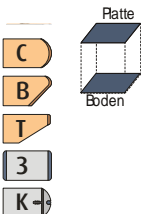
Mehrpreise für 1 Teil:

25mm Melamin	+293 €	+333 €		
25mm Laminat*	+322 €	+367 €		
25mm Furnier	+441 €	+514 €		
Bambus 20mm	+452 €	+480 €		

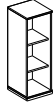
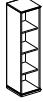

Mehrpreise Material und Oberfläche					
Seiten	1 OH 384mm	2 OH 768mm	3 OH 1152mm	4 OH 1536mm	5 OH 1920mm

Mehrpreise für 1 Teil:

19mm Melamin	Standard				
19mm Laminat	+55 €	+81 €	+108 €	+138 €	+157 €
19mm Furnier	+147 €	+208 €	+268 €	+330 €	+389 €
Bambus 20mm	+150 €	+222 €	+294 €	+452 €	+480 €

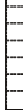

Mehrpreise Material und Oberfläche		
Seiten	6 OH 2304mm	7 OH 2560mm

Mehrpreise für 1 Teil:

19mm Melamin	Standard	
19mm Laminat	+199 €	+207 €
19mm Furnier	+435 €	+463 €
Bambus 20mm	+502 €	

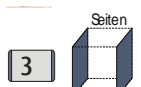



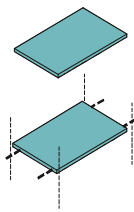

Modulschrank

Wählen Sie Ihr Zubehör







3

Fachboden					
	OZ-MFB04	OZ-MFB06 / MFB06M	OZ-MFB08 / MFB08M	OZ-MFB10 / MFB10M	
	400mm	600mm	800mm	1000mm	

Preise für 1 Teil:

19mm Melamin	32 €	41 €	48 €	58 €	
19mm Laminat	65 €	81 €	95 €	111 €	
19mm Furnier	157 €	190 €	222 €	256 €	

Fachboden					
	OZ-MFB04	OZ-MFB06 / MFB06M	OZ-MFB08 / MFB08M	OZ-MFB10 / MFB10M	
	400mm	600mm	800mm	1000mm	

Preise für 1 Teil:

25mm Melamin	45 €	59 €	71 €	87 €	
25mm Laminat*	66 €	83 €	98 €	115 €	
25mm Furnier	158 €	192 €	225 €	259 €	
Bambus 20mm	160 €	198 €	236 €	297 €	

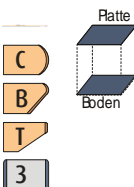

3

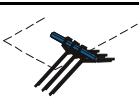
Hängerahmen	Preise für 1 Teil:			
	800mm 2xA4 MHR08	1000mm 2xA4 MHR10		ausz. Gard.stange MGA4
	auf Anfrage	auf Anfrage		auf Anfrage

Innenmaße der Querrolladenschränke für Fachböden und Hängerahmen	Schrankbreite	Innenmaß / Fachbodenbreite	
	800mm	660mm	
	1000mm	860mm	
	mit Mittelseite	Linke Seite	Rechte Seite
	1200mm	760mm	260mm
	1600mm	760mm	660mm
	2000mm	960mm	860mm





Wählen Sie Ihren ergonomischen Stuhl (passend zu runden Tischen)

Vital-Office Büro-Drehstuhl WEY

- Orthopädischer Sattelsitz - Drehstuhl WEY-chair 106
- Rückenlehne mit integrierten Armauflagen, Sattelsitz, Mechanik mit Sitz Neigeverstellung, Schiebesitz,
- hohe Gasfeder, Bezug (100.000 Martindale)
- Sattelsitz geformte Sitzfläche und höhere Gasfeder für gesundes Hoch-Sitzen mit offenen Hüftwinkel
- anthropometrisch geschäumte Rückenlehne in Kreuzform mit ausgeformter Lordosenstütze und weit auskragenden Ellbogenauflagen
- Bezüge mit hochwertiger Doppelnaht
- großes Fusskreuz für mehr Sicherheit bei erhöhtem Sitzen
- in jeder Position feststellbare Wippmechanik für dynamisches bewegtes Sitzen zur Kreislauf Unterstützung
- Gewichtseinstellung der Wippmechanik
- Rückenlehne in Höhe und Neigung einstellbar
- Sitzhöhen von 450-590mm gemessen an Vorderkante und 540-680mm gemessen an Hinterkante
- Gasliffeder in chrom mit 140mm Hub
- Sitztiefe einstellbar von 430-480mm
- Sitzfläche BT: 460x430mm
- Rückenlehne BTH: 600x200x630mm, 100mm Höhenverstellbar
- Aluminium Fusskreuz poliert Durchmesser 700mm
- Universalrollen für harte Böden und Teppichböden
- Maße: 607x660x985/1110mm







			
Stoff: Sitz schwarz, Rücken grau, schwarz, rot	WEY 106 Stoff 580 €	Leder schwarz	WEY 106 Leder 750 €
<p>Derzeit in Deutschland nicht an Lager. Lieferbar ab ca. 40 Stk.</p> 			
200mm Gasfeder für Sitzhöhe 505-700mm	+29 €		
Fussring	+50 €		

Option: Sonder Staffelpreise für kundenspezifische Konfiguration und palettenweise Abnahme 12- 336 Stk.

Wählen Sie Ihren Cheftisch

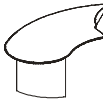

classic: Formteifüße in HG chrom, V2a, lackiert oder furniert	 classic cc1t20 2071x1227x750mm	 45° Anbau cc2k45L/R 1750x1227x750mm	 60° Anbau cc2k60L/R 1931x1048x750mm	 90° Anbau cc2k90L/R 2231x1083x750	 90° Winkel cc3w90 792x792mm
---	--	---	--	---	---

Platte in

25mm MDF Laminat*					
25mm MDF Furnier					
Bambus 20mm					
Bambus 40mm					



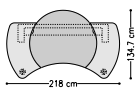
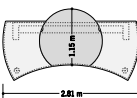
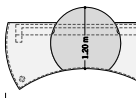

command: Rückwand in HG chrom, V2a, lackiert oder furniert	 command cc1c22 2180x1097x750mm	 command cc1c28 2808x1218x750mm	 command cc1c32 3208x1305x750mm		
---	--	--	---	--	--

Platte in

25mm MDF Laminat*					
25mm MDF Furnier					
Bambus 20mm					
Bambus 40mm					

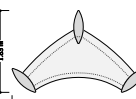
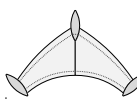

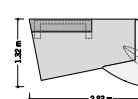
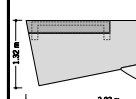

wing: Formteifüße in HG chrom, V2a, lackiert oder furniert	 wing cc1w30 3000x1830x750mm	 wing cc1w34 3390x2100x750mm	 jet:	 jet cc1j12L/R 2827x1317x750mm	 jet cc1j16L/R 3235x1317x750mm
--	---	---	--	---	---

Platte in

25mm MDF Laminat*					
25mm MDF Furnier					
Bambus 20mm					
Bambus 40mm					

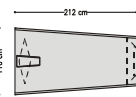

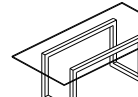
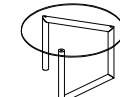

face: Formteifüße in HG chrom, V2a, lackiert oder furniert	 face cc1f01 2120x1100x810mm		Glass classics Aluminium Gestell	 cc1w21 2000x1000x750mm	 cc1w12 ø1200x750mm
--	---	---	-------------------------------------	--	--

Platte in

25mm MDF Laminat*					
25mm MDF Furnier					

Wählen Sie Ihren Empfang

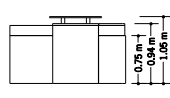
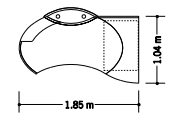

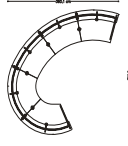
<p>check-in:</p> 	 <p>check-in cc1ci811/R 1850x1040x750</p>			
--	--	---	---	---

25mm MDF Melamin	
25mm MDF Laminat*	
25mm MDF Furnier	
Bambus 20mm	
Bambus 40mm	

individuelle Rezeptionen auf Anfrage

Wählen Sie Ihren Circon Konferenztisch

exklusive Konferenztische auf Anfrage

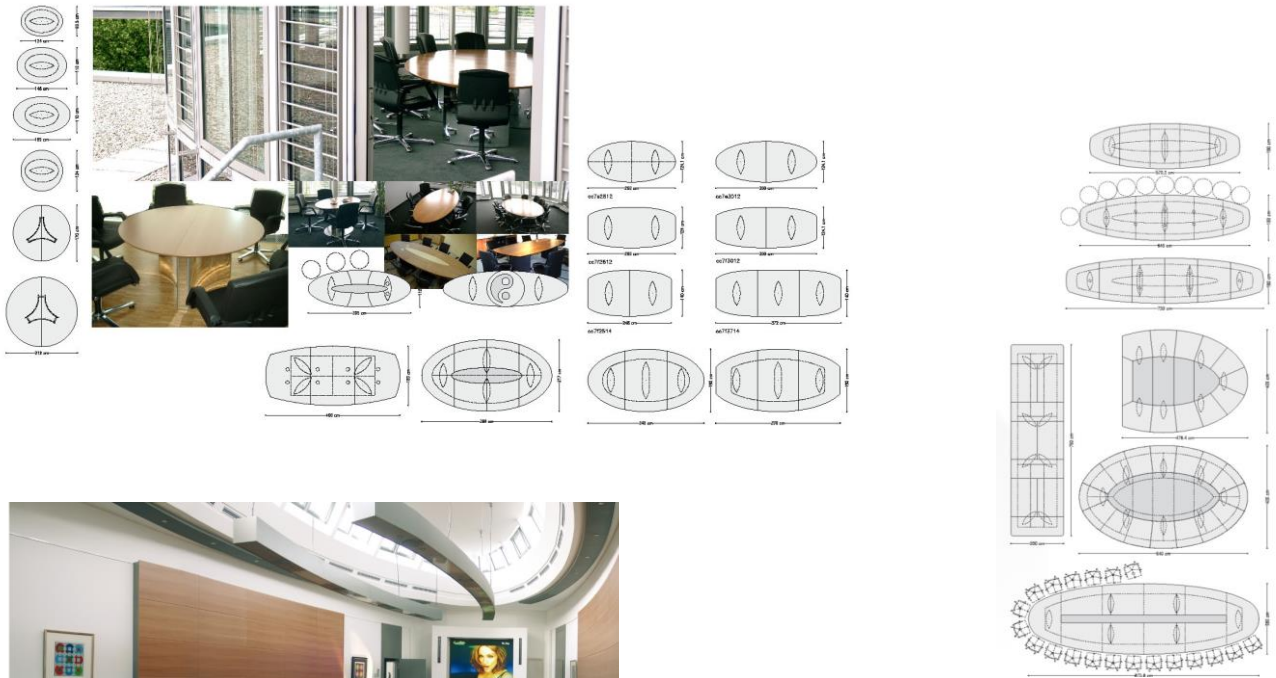
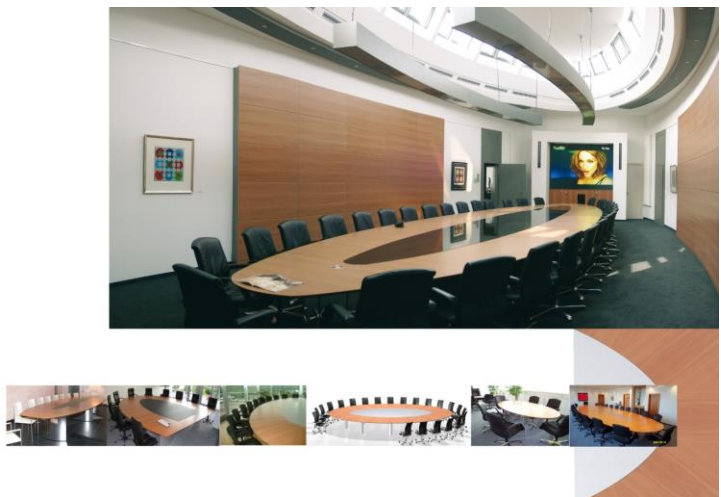

Bambus Massivholz
hell oder coffee

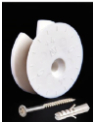

inklusive 2
Excenterhaken mit
Dübel und
Schrauben

Wählen Sie Frames

Rahmen aus Massivholz Bambus hell oder coffee mit vitAcoustic Füllung					
	VAF0404	VAF0804	VAF1204	Rahmen lackiert	VAF per m ²
PREMIUM PET	400x400mm	800x400mm	1200x400mm	Mehrpreis	mind. 1 m ²
H=45mm	315 €	366 €	406 €	+30 €	739 €
H=65mm	327 €	386 €	428 €	+40 €	787 €
H=85mm	339 €	406 €	450 €	+50 €	835 €
Moos	Mehrpreis	Mehrpreis	Mehrpreis		
	+150 €	+300 €	+450 €		Rahmen in individuellen Maßen für z.B. Schrankrückwände



3D-Frames

Eine spezielle Nut ermöglicht das einfache Wechseln der Inlays. Grazil dünne Rahmenstärke von nur 6mm.



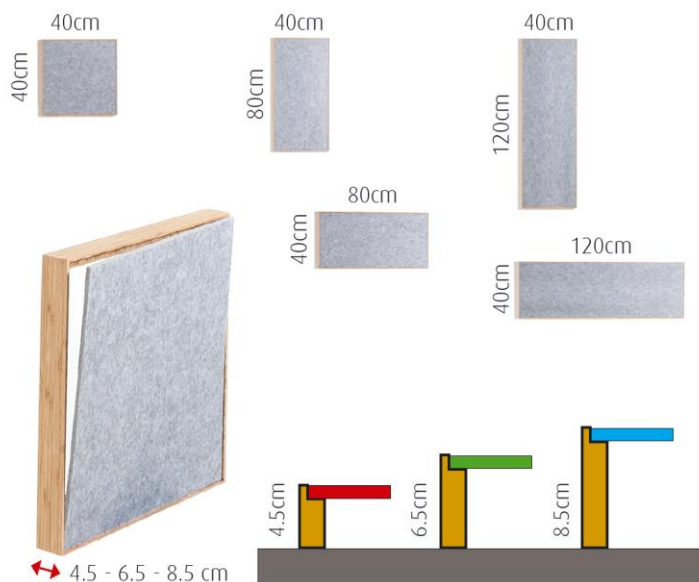

- Akustikkassette in verschiedenen Abmessungen
- Rahmen: Massivholz Bambus 18mm hell oder coffee geschliffen (NICHT geölt und nicht lackiert)
- Optional Rahmen geölt oder lackiert in verschiedenen Farben.
- Rahmenhöhe 45mm, 65mm oder 85mm
- Füllung: Polyethylen vitAkustik Platte 9mm stark - Qualität und Farbe nach Kollektion
- Optional: individuelle Bedruckung mit Ihrem Motiv.

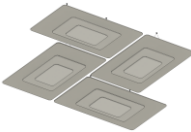
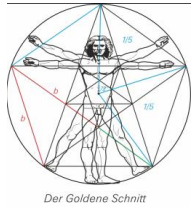





Wählen Sie rechteckige Deckensegel im Massverhältnis Goldener Schnitt $a / b = \varphi \approx 1,6180339887498948$





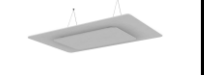



Rundungsradius:
(00) Keine Rundung
(10) 100mm Radius
(20) 200mm Radius
an Art.nr. anhängen

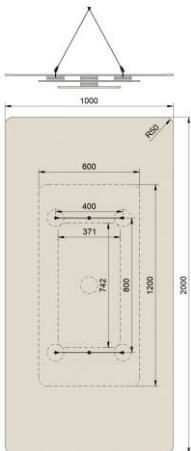
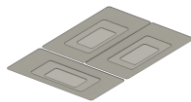

UNO-Deckensegel einlagig RECHTECK GOLDENER SCHNITT					
	2.33m ²	1.96m ²	1.62m ²	0.91m ²	0.58m ²
	VASCU12phi	VASCU11phi	VASCU10phi	VASCU08phi	VASCU06phi
H=9mm	1942x1200	1780x1100	1618x1000	1214x750	971x600
PREMIUM PET	317 €	302 €	287 €	196 €	151 €

DUO-Deckensegel doppellagig mit Abstand RECHTECK GOLDENER SCHNITT					
	3.22m ²	2.71m ²	2.24m ²	1.26m ²	0.81m ²
	VASCD12phi	VASCD11phi	VASCD10phi	VASCD08phi	VASCD06phi
H=9+27+9=45mm	1942x1200+1200x742	1780x1100+1100x680	1618x1000+1000x618	1214x750+750x464	971x600+600x371
PREMIUM PET	437 €	412 €	362 €	252 €	189 €

Wählen Sie rechteckige Deckensegel im Massverhältnis 1:2



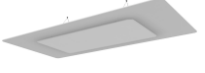
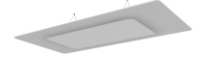
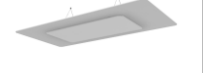



UNO-Deckensegel einlagig RECHTECK 1:2					
	2.88m ²	2.42m ²	2.00m ²	1.28m ²	0.72m ²
	VASCU1224	VASCU1122	VASCU1020	VASCU0816	VASCU0612
H=9mm	2400x1200	2200x1100	2000x1000	1600x800	1200x600
PREMIUM PET	349 €	325 €	308 €	266 €	158 €

DUO-Deckensegel doppellagig mit Abstand RECHTECK 1:2					
	3.98m ²	3.34m ²	2.76m ²	1.77m ²	1.00m ²
	VASCD1224	VASCD1122	VASCD1020	VASCD0816	VASCD0612
H=9+27+9=45mm	2400x1200+1483x742	2200x1100+1360x680	2000x1000+1200x600	1600x800+989x494	1200x600+742x371
PREMIUM PET	535 €	499 €	390 €	336 €	201 €





UNO-Deckensegel einlagig RECHTECK 1:2					
	1.44m ²				
	VASCU0624				
H=9mm	2400x600				
PREMIUM PET	307 €				

Wählen Sie Quadrat Deckensegel im Massverhältnis Goldener Schnitt $a / b = \varphi \approx 1,6180339887498948$







UNO-Deckensegel einlagig QUADRAT					
	VASQU12	VASQU11	VASQU10	VASQU08	VASQU06
H=9mm d=Umkreis	x ² =1200	x ² =1100	x ² =1000	x ² =800	x ² =600
PREMIUM PET	221 €	209 €	203 €	162 €	125 €

Rundungsradius:
(00) Keine Rundung
(10) 100mm Radius
(20) 200mm Radius
an Art.nr. anhängen





DUO-Deckensegel doppellagig mit Abstand QUADRAT GOLDENER SCHNITT					
	VASQD12phi	VASQD11phi	VASQD10phi	VASQD08phi	VASQD06phi
H=9+27+9=45mm	x ² =1200+742	x ² =1100+680	x ² =1000+618	x ² =800+494	x ² =600+371
PREMIUM PET	303 €	287 €	252 €	205 €	156 €

Wählen Sie runde Deckensegel









UNO-Deckensegel einlagig RONDE					
	1.13m ²	0.95m ²	0.79m ²	0.50m ²	0.28m ²
	VASRU12	VASRU11	VASRU10	VASRU08	VASRU06
H=9mm	d=1200	d=1100	d=1000	d=800	d=600
PREMIUM PET	202 €	190 €	184 €	143 €	106 €

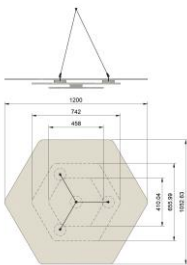



Rundungsradius:
(00) Keine Rundung
(10) 100mm Radius
(20) 200mm Radius
an Art.nr. anhängen

DUO-Deckensegel doppellagig mit Abstand RONDE GOLDENER SCHNITT					
	1.56m ²	1.31m ²	1.09m ²	0.69m ²	0.39m ²
	VASRD12phi	VASRD11phi	VASRD10phi	VASRD08phi	VASRD06phi
H=9+27+9=45mm	d=1200+742	d=1100+680	d=1000+618	d=800+494	d=600+371
PREMIUM PET	284 €	268 €	233 €	186 €	137 €

Wählen Sie Hexagon Deckensegel









UNO-Deckensegel einlagig HEXAGON					
	VASHU12	VASHU11	VASHU10	VASHU08	VASHU06
H=9mm d=Umkreis	d=1200	d=1100	d=1000	d=800	d=600
PREMIUM PET	202 €	190 €	184 €	143 €	106 €

DUO-Deckensegel doppellagig mit Abstand HEXAGON GOLDENER SCHNITT					
	VASHD12phi	VASHD11phi	VASHD10phi	VASHD08phi	VASHD06phi
H=9+27+9=45mm	d=1200+742	d=1100+680	d=1000+618	d=800+494	d=600+371
PREMIUM PET	284 €	268 €	233 €	186 €	137 €

Wählen Sie Wolken Deckensegel





Wolkenform					
	VASCW1709	VASCW1809	VASCW1407	VASCW1508	
H=9+27+9+27+9=81mm	1700x874	1800x853	1400x729	1500x755	
PREMIUM PET	279 €	283 €	257 €	262 €	

Wolkenform					
	VASCW1207	VASCW1208	VASCW1206		
H=9+27+9+27+9=81mm	1200x669	1200x732	1200x600		
PREMIUM PET	190 €	196 €	158 €		

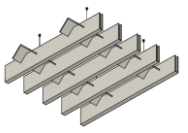
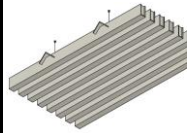

Wählen Sie Baffeln

Baffelset					
	VABA1212-0418x5	VABA2112-0815x8		Montagekleber (getestet)	VAZ-DB1
PREMIUM PET	1200x1200	2100x1200		425gr	Seilset
	670 €	1'154 €		19	19
	3.84 m ²	7.02 m ²			



Wählen Sie Kassetten und Stellwand

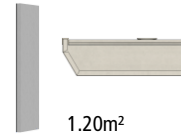
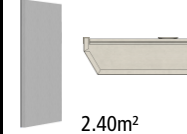
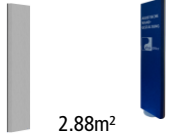
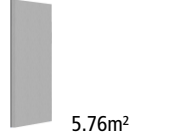

Kassetten für Wand und Decke mit Aluprofil längs und 4 Excenterhaken mit Dübel und Schrauben			Stellwand Facette beidseitig höchst absorbierend A-Klasse. mit Aluprofil längs und standfester Bodenplatte		
	1.20m ²	2.40m ²		2.88m ²	5.76m ²
	VAKS0520	VAKS1020		VAKW0520	VAKW1020
Dicke=70mm	500x70x2000	1000x70x2000	Dicke=100mm	500x100x<=2400	1000x100x<=2400
PREMIUM PET	271 €	432 €	PREMIUM PET	782 €	1'207 €



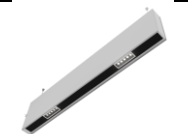
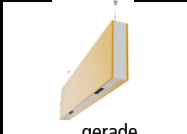
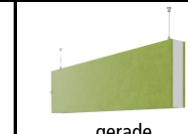

Wählen Sie Stellwand

Stellwand 100R beidseitig höchst absorbierend A-Klasse. mit Aluprofil längs und standfester Bodenplatte					
	2.88m ²	5.76m ²			
	VAKR0520	VAKR1020			
Dicke=100mm	500x100x<=2400	1000x100x<=2400			
PREMIUM PET	832 €	1'280 €			

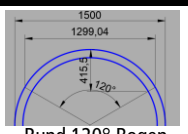
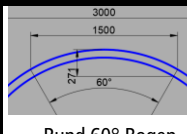

Akustik-Licht-Baffel 81

Akustikmodul für Licht					
	VABL81-0600x290	VABL81-1200x290	VABL81-1600x290	VABL81-2000x290	VABL81-2300x290
Dicke=81mm	600x290x81	1200x290x81	1600x290x81	2000x290x81	2300x290x81
PREMIUM PET	376 €	461 €	561 €	596 €	621 €

Akustik-Licht-Baffel 81





Akustikmodul für Licht				
	Rund 120° Bogen	Rund 60° Bogen		
	VABL81-d1500-120°-R	VABL81-d3000-60°-R		
Dicke=81mm	1300x290x416/81	1500x290x271/81		
PREMIUM PET	748 €	748 €		



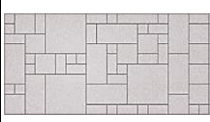

Akustik-Licht-Modul



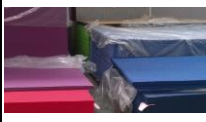

Lichtelemente für Akustikmodul - Teile in Akustikmodul montiert ohne E-Anschluss -				Elektroinstallation pro Lichtmodul inkl. Kabel und Schukostecker
	Lineares Licht im Aluprofil 13.5W/m, 3000K/4000K, Trafo CV	3000K 800lm mit Netzgerät dimmbar	3000K 1600lm mit Netzgerät dimmbar	
	VADL-13.5W-4000K-m	VADL-CETI5	VADL-CETI10	VALM-Montage1
	pro angef. Meter	137x44	257x44	
	116 €	146 €	222 €	36 €



Wählen Sie Fliesen mit und ohne Textur



Fliesen für Wandverkleidungen Verpackungsgrößen: ab 4 Stk. / Farbe im Karton					
	VAT1206-Bricks	VAT1206-Triangle-V	VAT1206-Triangle-D	VAT1206 ohne Textur	VAPL1224
Rundum mit Fasen	1200x600x9	1200x600x9	1200x600x9	1200x600x9	2440x1220x9
PREMIUM PET	48 €	48 €	48 €	40 €	156 €
	66.06 €/qm	66.06 €/qm	66.06 €/qm	55.81 €/qm	54.03 €/qm

Latten mit Bohrungen und Sockelleiste MDF roh zum selbst anstreichen					
	Latte MDF mit Bohr.	PET Dämmplatte	PET Dämmplatte	Holzfaser Dämmplatte	Holzfaser Dämmplatte
	VATL2405	VATC35-120604	VATC35-120606	VATDF5-120604	VATDF5-120606
	2400x40/60x25	1200x600x40	1200x600x60	1200x600x40	1200x600x60
PREMIUM PET	10 €	auf Anfrage	auf Anfrage	26 €	37 €
	4.35 €/m			36.49 €/qm	53.17 €/qm

Verbundplatte aus homogener Dämmplatte und dekorativer vitAcoustic Platte					
	Verbundplatte Holzfaser	Verbundplatte Holzfaser	Verbundplatte PET	Verbundplatte PET	Randstreifen
	VATV1206-DF5-40	VATV1206-DF5-60	VATV1206-C35-40	VATV1206-C35-60	VATVR1000x50
Rundum mit Fasen	1200x600x49	1200x600x69	1200x600x49	1200x600x69	per m
PREMIUM PET	92 €	104 €	auf Anfrage	auf Anfrage	12 €
	127.99 €/qm	144.25 €/qm			

Wählen Sie die Größe der Vorhangbahnen, Laufschiene und Konfektion

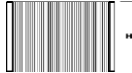
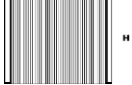

Vorhangbahnen rechteckig zugeschnitten					
PREMIUM PET B\H	400	600	800	1000	1200
400	31 €	38 €	46 €	56 €	60 €
600	38 €	49 €	60 €	75 €	82 €
800	51 €	69 €	86 €	112 €	120 €
1000	60 €	80 €	99 €	127 €	137 €
1200	60 €	82 €	103 €	133 €	145 €





Vorhangbahnen rechteckig zugeschnitten					
PREMIUM PET B\H	1400	1600	1800	2000	.. mit Textur oder ausgeschnittenem Muster Zuschlag +50% + CNC Einrichtung einmalig +100 €
400	82 €	87 €	91 €	96 €	
600	114 €	121 €	127 €	134 €	
800	181 €	190 €	198 €	207 €	
1000	200 €	211 €	221 €	232 €	
1200	210 €	223 €	235 €	248 €	

vitAcoustic Flächenvorhänge Laufschiene und Konfektion:	Preis per Bahn für Konfektion, Aufhängeprofil		Flächenvorhang Laufschiene Set 5-läufig weiß, inklusive Panelwagen frei positionierbar		
	pro Bahn FKM-1000kp			1m FKM-1001	Wandwinkel FKM-1001w
	55 €			54 €	3 €

vitAcoustic Partition







Gerade superleichte Trennwandelemente wahlweise mit Tischklemme oder Standfuß.

Wählen Sie die Größe der Partition					
Akustikpartition PREMIUM PET Aluminium Profile vertikal					
Breite\Höhe	400	600	800	1000	1200
400	42 €	122 €	130 €	140 €	186 €
500	78 €	130 €	140 €	154 €	201 €
600	80 €	133 €	144 €	159 €	208 €
800	93 €	153 €	170 €	196 €	246 €
900	96 €	156 €	174 €	201 €	253 €
1000	102 €	164 €	183 €	211 €	263 €
1200	102 €	166 €	187 €	217 €	271 €
1400	124 €	198 €	265 €	284 €	336 €
1600	129 €	205 €	274 €	295 €	349 €
1800	133 €	211 €	282 €	305 €	361 €
2000	138 €	218 €	291 €	316 €	374 €

vitAcoustic Flexi Partition



Modulare flexible Trennwandelemente, wahlweise mit Tischklemme oder Standfuß.
(Die Matte reicht bis zum Boden und verhindert Luftzug)

Wählen Sie die Größe der Flexi Partition					
Flexible Akustikpartition PREMIUM PET Profile vertikal					
Breite\Höhe	400	600	800	1000	1200
400	177 €	192 €	208 €	228 €	239 €
500	187 €	206 €	225 €	251 €	264 €
600	234 €	255 €	276 €	304 €	318 €
800	259 €	289 €	320 €	364 €	382 €
900	264 €	297 €	329 €	374 €	393 €
1000	284 €	317 €	351 €	398 €	419 €
1200	323 €	360 €	397 €	447 €	471 €
1400	361 €	414 €	521 €	561 €	574 €
1600	414 €	471 €	580 €	624 €	640 €
1800	425 €	485 €	598 €	645 €	664 €
2000	436 €	499 €	615 €	665 €	688 €

Akustik Absorption 9mm Premium PET 2.0kg/m² = Höchstabsorbierend Klasse B $\alpha_w = 0.80$

Upgrade 2x9mm = 18mm: Aufpreis 100%



Akustik Absorption 18mm Premium PET 4.0kg/m² = Höchstabsorbierend Klasse A $\alpha_w = 0.95$

vitAcoustic Partition

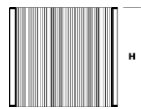
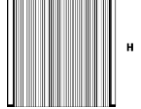

Gerade superleichte Trennwandelemente wahlweise mit Tischklemme oder Standfuß.

Wählen Sie die Größe der Partition

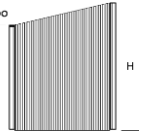
Akustikpartition PREMIUM PET Aluminium Profile vertikal										Gerade oder Schräg			
	Breite\Höhe	1400	1600	1800									
400	208 €	255 €	259 €										
500	233 €	281 €	286 €										
600	240 €	289 €	295 €										
800	307 €	358 €	366 €										
900	315 €	366 €	375 €										
1000	326 €	379 €	389 €										
1200	336 €	391 €	403 €										

vitAcoustic Flexi Partition



Vorteil: Modulare flexible Trennwandelemente, wahlweise mit Tischklemme oder Standfuß.
(Die Matte reicht bis zum Boden und verhindert Luftzug)



Wählen Sie die Größe der Flexi Partition

Flexible Akustikpartition PREMIUM PET Profile vertikal										Gerade oder Schräg			
	Breite\Höhe	1400	1600	1800									
400	361 €	414 €	425 €										
500	401 €	456 €	468 €										
600	414 €	471 €	485 €										
800	521 €	580 €	598 €										
900	534 €	595 €	614 €										
1000	561 €	624 €	645 €										
1200	574 €	640 €	664 €										

Wählen Sie Standfuß, Tischklemmen und Verbinder

Zubehör			
	Standfuß silber Standfuss sys12	Tischklemmen (2Stk.) aps20tk7	Kabelclipe (5 Stk.) aps20kc5
	81 €	98 €	19 €

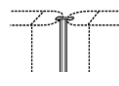

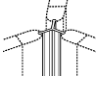
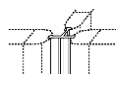
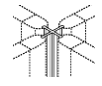

Zubehör					
	Verbinders linear FSO S23 9003 0002	Scharnier 2-fach FSO S23 5002 0002	Verbinders 3-fach FSO S23 9002 0003	Verbinders 3-fach FSO S23 9002 0007	Verbinders 4-fach FSO S 23 9002 0004
	38 €	38 €	50 €	50 €	52 €



Zubehör					
	1000mm	1200	1400	1600	1800
	Organisationsleiste aps20ol10	Organisationsleiste aps20ol12	Organisationsleiste aps20ol14	Organisationsleiste aps20ol16	Organisationsleiste aps20ol18
	106 €	127 €	148 €	170 €	191 €

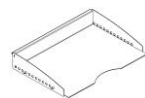
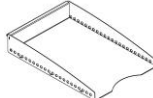
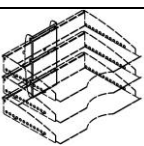

Zubehör					
	Schale A4 quer aps20olA4q	3x Schale A4 quer aps20olA4qx3	Schale A4 lang aps20olA4l	Zettelbox aps20olz	Stiftebox aps20olsb
	41 €	106 €	41 €	50 €	37 €



Zubehör		
	Stehsammler aps20olss	Blumenvase aps20olbv
	59 €	46 €

Wählen Sie Ihren Zimmerbrunnen aus massivem Sandstein



Zimmerbrunnen	Vital-Office Zimmer-Brunnen aus einem massivem Sandsteinquader mit Beckenaussparung (Trog) Oberfläche gesägt und 80er Korn geschliffen und eingelassen mit Brunnenpumpe, Schlauch, Befestigung, Bohrlochdichtmittel .. mit Beleuchtung von innen: Lichtfarbe weiß mit Plexiglasdeckel transparent, transluzent (Satina) oder bedruckt .. Motive nach Wahl	
	480x480x380mm STZ-Brunnen48	
	2'570 €	



Handmuster	8d1b45	Dekorketten	Melaminharz Standarddekore	Echtholz Furnierkette
	Joker 168 Swatch 400x205mm		Nettopreise!	
	Nettopreise!		kostenlos	15 €
25mm MDF Melamin	25 €			
25mm MDF Furnier	N/A			
Bambus 20mm	25 €			
Bambus 25mm	N/A			
Bambus 40mm	N/A			
25mm MDF Laminat*	N/A			

Ausschreibungstext
Ergonomische Schreibtische
mit modularen Variationen:

- Anthropometrische Innenrundung, damit die Arbeitsmittel auf der Tischfläche durch eine leichte Körperdrehung, ähnlich einer Winkelkombination, in gleichbleibendem Sicht- und Greifabstand erreichbar sind. Die Innenrundung ist so zum Benutzer hin geformt dass keine zusätzlich Nutzerfläche nach EU Norm beansprucht wird. - Die Außenform ist wahlweise rund oder facettiert OHNE Mehrpreis lieferbar. - Die Tischplatte ist an jeder Stelle mindestens 800mm tief. - Die Tischplatte ist aus 28mm stabilen melaminharzbeschichteten MDF Platten (keine Spanplatte) hergestellt und an allen Kanten rundum mit einem Profil in rund oder facettiert, nach Wahl versehen. - Die Kanten der Tischplatte sind widerstandsfähig ökologisch gewachst (kein Kunststoffanleimer) - Die Tischplatte ist inklusive der Kanten ein homogenes umweltfreundliches Holzprodukt und enthält keine bei der Entsorgung umweltschädliche Verbundteile, wie z.B. Kunststoffanleimer) - Die Widerstandsklasse für Melaminharzbeschichtung ist gemäß EN14322, Melaminharzbeschichtung für Klasse 1 – neuester Stand der Technik – zu erfüllen. Die Kunststoffoberflächen müssen blendfrei und strukturiert sein. Der Glanzgrad muss seidenmatt entsprechen. Reflektionsgrade dürfen nicht außerhalb der Richtwerte gemäß DIN 4554 liegen. - Bei Einsatz von Echtholzfurnier ist eine Furnierstärke von mindestens 0,6 mm gefordert, mindestens 2 mal lackiert und UV-getrocknet und gehärtet. Es werden ausschließlich formaldehydfreie Lacke verwendet. - Als Trägermaterial dürfen nur MDF Platten mindestens der Klasse E1 nach EN 312 eingesetzt werden. - Kabeldurchführungen in Metall (kein Kunststoff) - Kabelkanal / Kabelwanne - Vertikale Kabelführung. Mit folgenden modulare Variationen: - Tischplatten in umweltfreundlichem Bambus Massivholz aus ökologischem Anbau, wahlweise lackiert oder geölt, wahlweise in coffee gedämpft oder natur hell - Ergonomische Abflachung der Tischkante an der Benutzerseite - Zum Tisch und Gestell passende, werkzeugfrei abnehmbare Sichtblenden, wahlweise in Holz oder Acrylglas gebogen - Sichtblenden individuell bedruckt - Höhenverstellbares Steh- Sitzgestell mit Kurbelverstellung. Verstell Bereich mindestens 700-1180mm - Höhenverstellbares Steh- Sitzgestell mit motorischer Verstellung. Verstell Bereich mindestens 630-1280mm mit automatischem Klemmschutzstop, sanftem Start – Stopp und elektronischer Stromsparender Steuerung.

Ausschreibungstext
für Container und Caddy:

- Die Container bestehen aus 19 mm starken Spanplatten (melaminharz-/Kunststoffbeschichtet oder furniert). - Die Platte, Rückwand und Frontstücke der Schübe stehen seitlich zum Korpus (Seiten) über, so dass die Schubladen seitlich geöffnet werden können und gleichzeitig das Gesamtdesign bündig kubusförmig bleibt. - Alle Containertypen sind von unten durch einen Boden aus Stahlblech verschlossen - Die Aufnahme der Rollen bzw. der Sockelfüße stützen sowohl den Unterboden als auch die Containerseiten ab, um die Gewichtsbelastung zusätzlich aufzunehmen. Die Rollen sind in Gewinde des Stahlbodens montiert. - Jede Schublade (außer Materialauszug) ist bis zu 45 kg belastbar. - Container auf Rollen sind mit verdeckten, allseitig drehbaren und zusätzlich feststellbaren Doppelrollen auszustatten. - Es gelten die Materialanforderungen aus dem ausgeschriebenen Tischprogramm. - Die Auszüge sind nachträglich austauschbar und nachrüstbar. - Alle Container enthalten eine ergonomisch gestaltete Materialschale auf Ganzmetall-Teleskopführung. - Alle Schubladen sind in Stahl ausgeführt, mit verdeckten Führungen, leicht und geräuschlos laufend. Eine unbeabsichtigte Entnahme des Schubkastens von der Führung ist nicht möglich. - Alle Schubladen besitzen einen Selbststeinzug in Endbereich. - Alle Schubladen können optional anstatt mit 4/5 Auszug auch als Voll-/Überauszug geliefert werden (mit Mehrpreis) - Alle Schubladen sind mit Dämpfung ausgestattet (Standard) - Alle Schubladen mit Hängeregistratur besitzen einen Vollauszug von 10 mm und sind korpusseitig mit Stützrolle ausgeglichen. - Alle Container sind mit Auszugssperre und Zentralverschluss mit Wechselylinder auszustatten. - Das Schloss ist in der Front zu integrieren, darf aber nicht zu Verlust von Stauraum führen. Je Container sind 2 Schlüssel mitzuliefern. Die Ausbildung kompletter Schließkreise muss als Option möglich sein. - Folgende Organisationselemente müssen für die Schübe zur Verfügung stehen: - Trennsteg quer A4 / Stellbrettchen - Stempelhalter - Formularablagen

Ausschreibungstext
für Schränke:

- Modulares System in einheitlichem Design über alle Schranktypen - Wahlweise als Unter- und Aufsatzschrank verwendbar - Nachrüstbare Türen - Schrankelemente mit Flügeltüren, Schiebetüren, Querrolladen, Flügeltüren und Vertikalrolladen müssen miteinander im gleichen Rastermaß kombinierbar sein, das heißt die Addition mehrerer Ordnerhöhen ergibt eine neue ungeteilte Ordnerhöhe. - Alle Schrankelemente müssen zu einer kompletten Schrankwand ausbaubar sein, die auch als Raumteiler genutzt werden kann. Vor Wand oder als Raumteiler können in die Schrankwand Durchgangstüren, Oberlichter, Küchenzellen, Nasszellen, Tresore, usw. integriert werden. - Im gleichen System sind unterschiedliche Frontausführungen möglich. - Sämtliche Fronten sind verschleißbar. - Alle Inneneinrichtungen sind höhenvariabel im Raster von 32 mm montierbar und gegenseitig austauschbar. - Sockel umlaufend, 100 mm hoch von innen höhenverstellbar, Verstellbereich 30 mm, alternativ: - Sockelplatte 28 mm hoch von innen höhenverstellbar, Verstellbereich 10mm; alternativ: - Verstellgleiter von innen höhenverstellbar, Verstellbereich 10mm - Ausreichende Stabilität, um bodenstehende Elemente auch wandhängend einsetzen zu können. - Korpen, Fronten, Holzfachböden und Holzabdeckplatten sind in Kunststoff-Ausführung mit Melaminharz beschichtet oder in Echtholz-Ausführung mit 0,6 mm Furnierstärke auszuführen. Grundsätzlich sind beide Oberflächenarten alternativ lieferbar, auch in der Kombination Korpus in Kunststoff-Ausführung mit Echtholz- furnierter Front. - Es gelten die Materialanforderungen aus dem ausgeschriebenen Tischprogramm. - Alle Kanten müssen bündig und gratfrei sauber und vollflächig an den Platten verleimt sein. - Wandstärke Korpus 19 mm Gütefeinspanplatte mit Kantenradius 2 mm - 8 mm starke, eingenetete, Rückwand - Sichrückwand 19 mm stark aufgesetzt (optional) - Fachboden (melaminharzbeschichtete Spanplatte) in Korpusfarbe 19 mm stark, ab 1.000 mm Korpusbreite 25 mm stark, Fachbodenträger greift mit Dorn in Fachboden - Ausziehbare 2-bahnige Hängerahmen mit Auszugssperren - Dreipunktdrehstangenverriegelung in Metall, Schloss mit Wechselylinder für Flügeltüren - Öffnungswinkel mindestens 115°

Dienstleistungs- pauschalen unter Vorbehalt der regionalen Verfügbarkeit	UVP (Brutto) Regelung Warenwerte nach Preisliste (= Brutto) (% Zuschläge werden vom Bruttowert berechnet)			
	2000-5000€	bis 10 000€	> 10 000€	Avis / Express
Neue Verpackungs- und Transportkosten ab 01.05.2022				
Lieferung innerhalb Deutschland - frei Bordsteinkante- per Stückgutspedition auf Palette verpackt.	+180 € netto	+ 3.5% mindestens 180 € netto	+ 3.5%	Avis durch Spedition +30,- Express: Garantierte Zustellung bis 10:00/12:00 Uhr +90,-
Lieferung Österreich und Schweiz (unverzollt) - frei Bordsteinkante- per Stückgutspedition auf Palette verpackt.	+240 € netto	+ 4.5% mindestens 240 € netto	+ 4.5%	auf Anfrage
Verpackungszuschlag für Aufträge unter 2000,-€ mit großer Palettenverpackung z.B. für Tischplatten	+70 € netto		Montagen:	auf Anfrage

Voraussetzungen: Die genannten Warenwerte beziehen sich stets auf geschlossene (d.h. zeitlich nicht verteilte) Anlieferungen. **Wir behalten uns vor, für Einzellieferungen unter 1000 € Netto-Warenwert die genannten Dienstleistungen nicht vorzunehmen.** Wir erwarten, dass der Fachhändler zu den avisierten Lieferzeiten entweder beim Endkunden selbst vor Ort ist oder alles organisiert ist bzw. das Lager zu den avisierten Zeiten besetzt ist. Die Anfahrt für LKW mit Anhänger (18m-Zug) und ein zügiges Entladen müssen möglich sein, andernfalls wird ein Zuschlag erhoben. Für das Vertragen unter/über das Erdgeschoss muss ein geeigneter Lastenaufzug vorhanden sein, andernfalls kann ebenfalls ein Zuschlag erhoben werden. Die Baustelle muss gefahrlos begangen werden können, d.h. keine fehlende Treppengeländer und dergleichen und muss frei von Baustaub sein. Die Büroräume müssen leerräumt und frei von Bauschutt sein. Die üblichen Anlieferzeiten sind von Montag bis Freitag 8.00 – 17.00 Uhr. Sind die Voraussetzungen nicht gegeben, erfolgt der zusätzliche Aufwand im Stundennachweis.

Die Montagedienstleistungen beziehen sich ausschließlich auf Standard Büromöbel wie Tische und frei aufzustellende Modulschränke. Einbauten wie z.B. Verblendungen sind nicht in den Pauschalen enthalten.
Montage von Akustikabsorbentern ist ebenfalls gesondert anzufragen.

Gemäß AGB ist unsere Leistung mit der Übergabe der Ware an den Spediteur erfüllt. Verzögerungen in der Lieferung und Abnahme der Ware durch den Kunden (z.B. bei Montagedienstleistungen) berechtigen nicht zur Verlängerung der Zahlungsziele. Rechnungen werden zum Zeitpunkt der Lieferbereitschaft versandt. Skonto- und Zahlungsfristen gelten ab Rechnungsdatum.



Alle Preise zzgl. gesetzl. MwSt.
Objektliste nur für Distributoren
und Großkunden bestimmt
Änderungen vorbehalten.
www.vital-office.net